

Chapter 7

Wireless and Mobile Networks

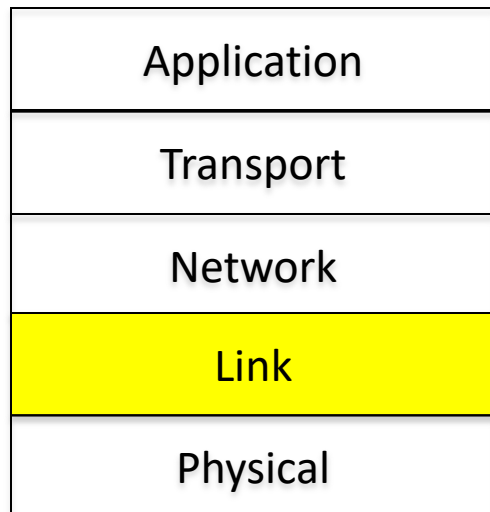

- WiFi (WiFi 5/6/6e/7...)
- Cellular (4G/5G/6G...)

Wireless and Mobile Networks: context

- more wireless (mobile) phone subscribers than fixed (wired) phone subscribers (10-to-1 in 2019)!
- more mobile-broadband-connected devices than fixed-broadband-connected devices (5-1 in 2019)!
 - 4G/5G cellular networks now embracing Internet protocol stack, including SDN
- two important (but different) challenges
 - **wireless**: communication over wireless link
 - **mobility**: handling the mobile user who changes point of attachment to network

Chapter 7 outline

- Introduction

Wireless

- Wireless Links and network characteristics
- WiFi: 802.11 wireless LANs
- Cellular networks: 4G and 5G

Mobility

- Mobility management: principles
- Mobility management: practice
 - 4G/5G networks
 - Mobile IP
- Mobility: impact on higher-layer protocols



Elements of a wireless network

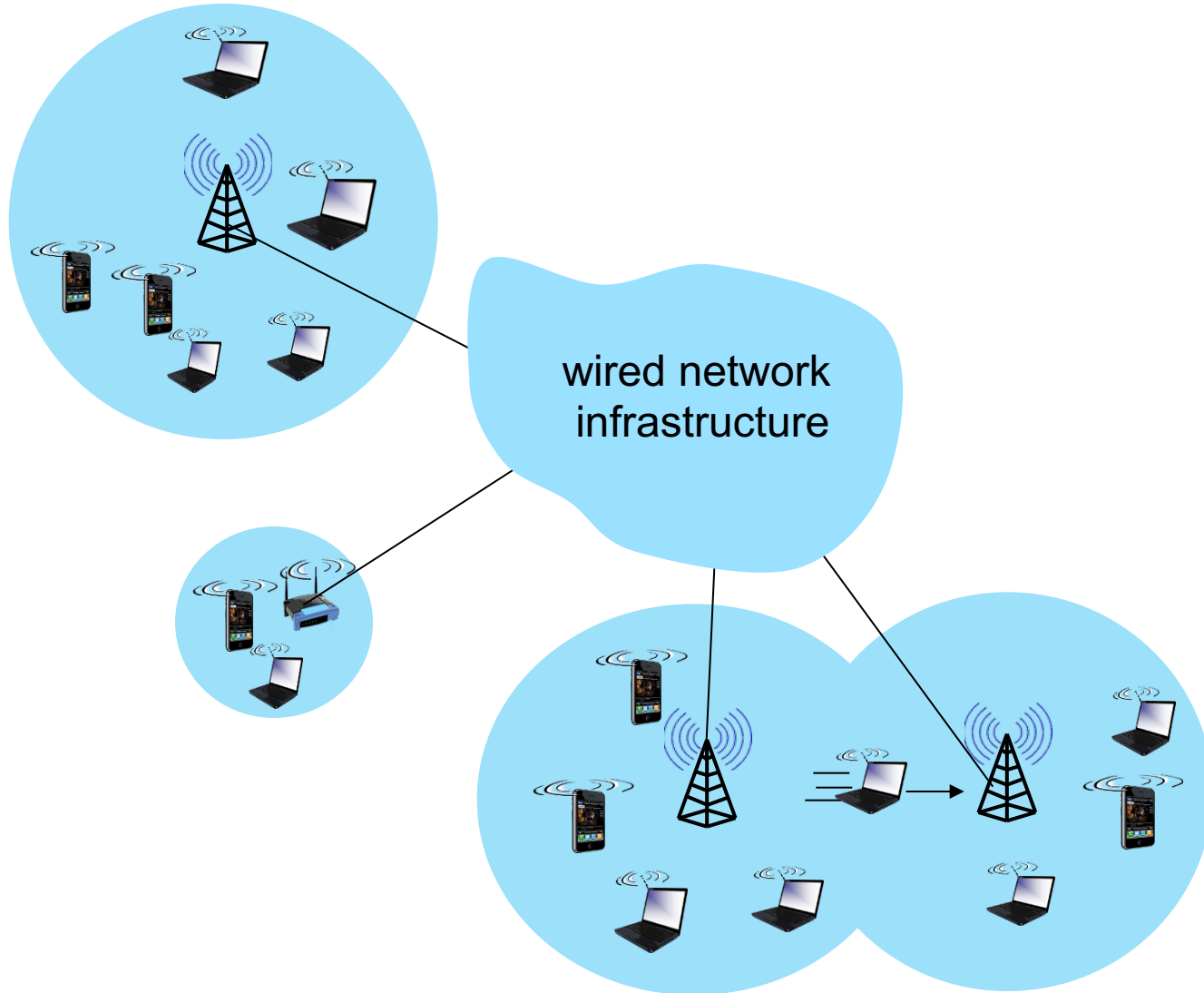

Elements of a wireless network

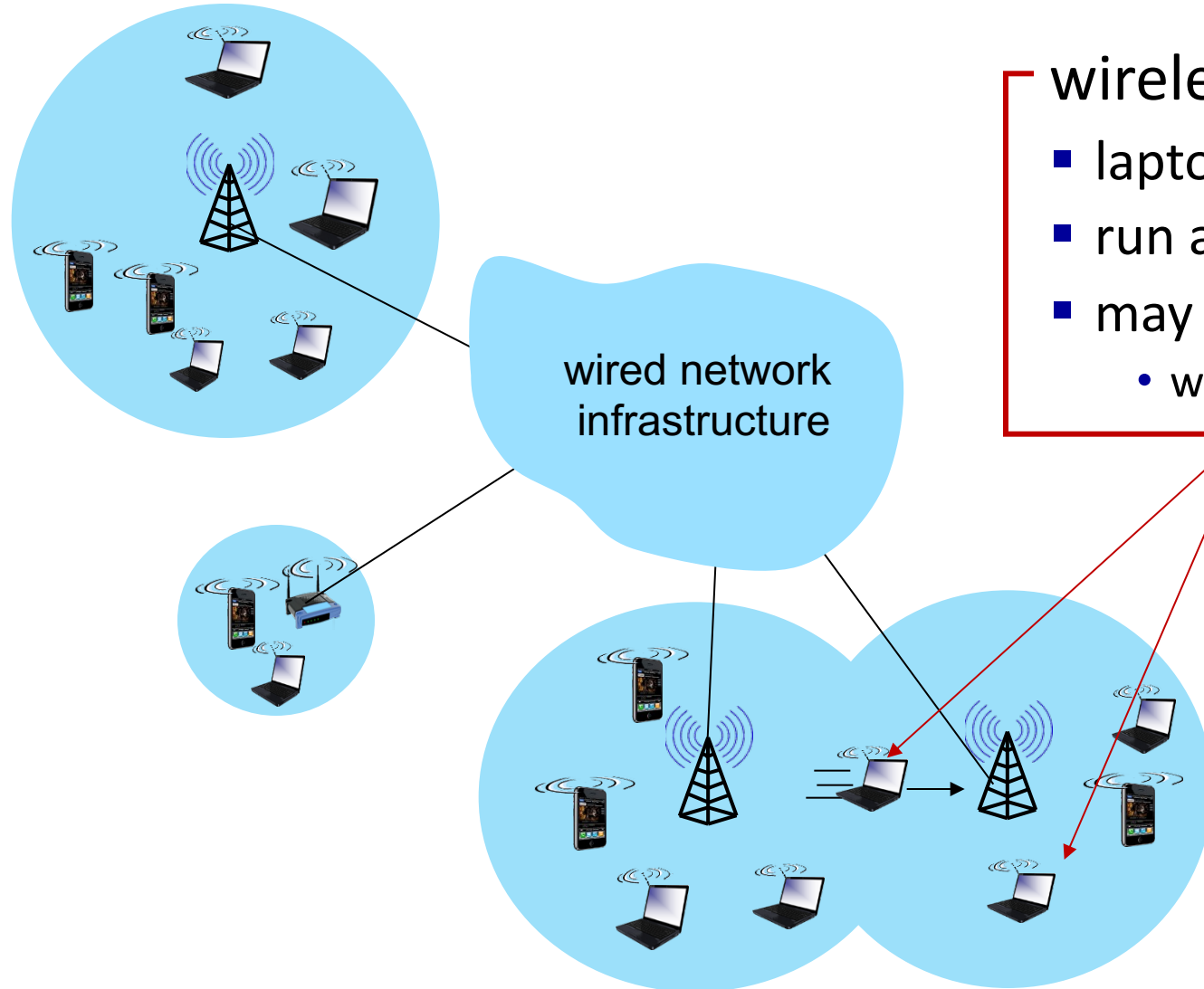

wireless hosts

- laptop, smartphone, IoT
- run applications
- may be stationary (non-mobile) or mobile
 - wireless does *not* always mean mobility!



Elements of a wireless network

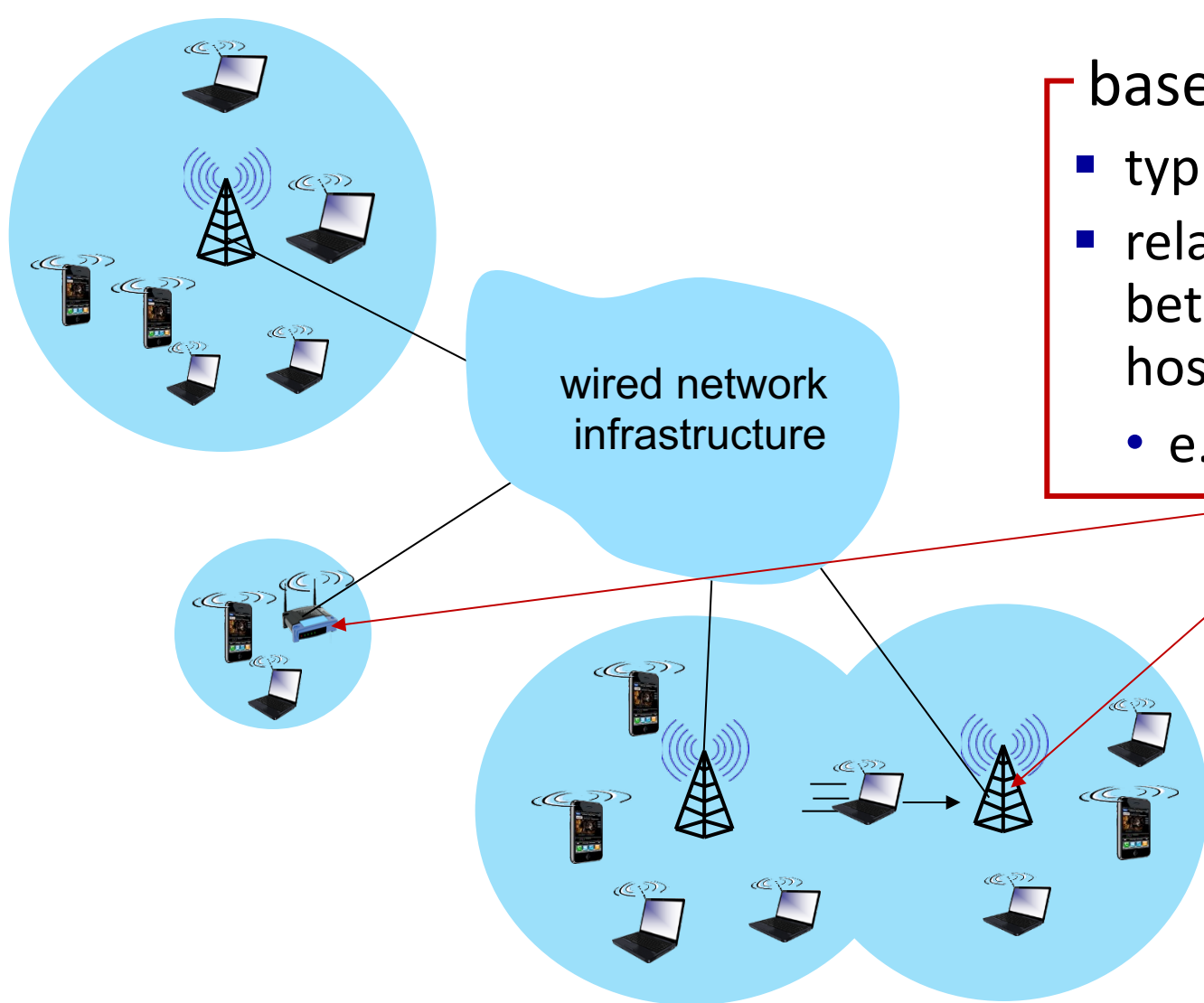

base station



- typically connected to wired network
- relay - responsible for sending packets between wired network and wireless host(s) in its “area”
 - e.g., cell towers, 802.11 access points

Elements of a wireless network

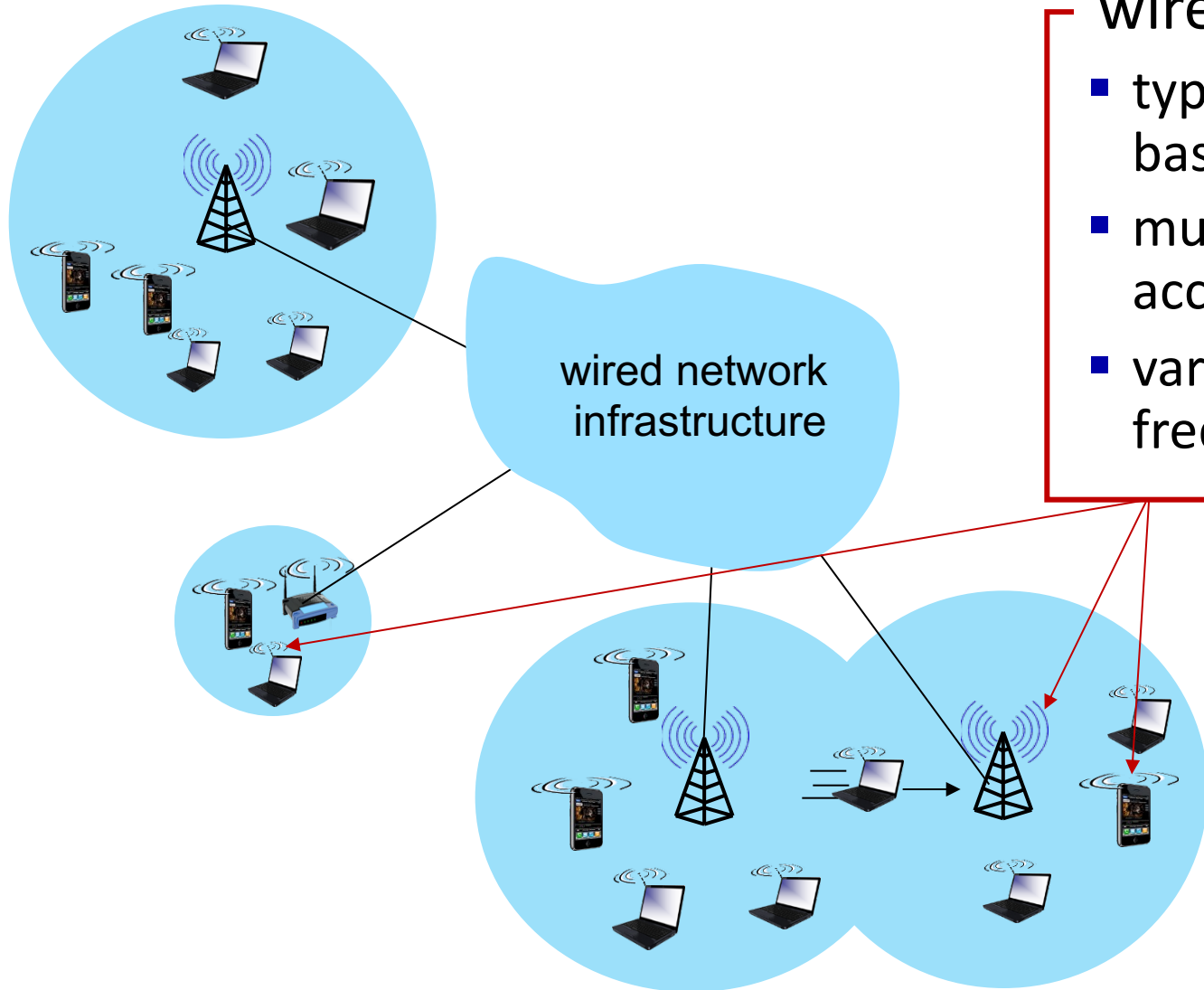

wireless link



- typically used to connect mobile(s) to base station, also used as backbone link
- multiple access protocol coordinates link access
- various transmission rates and distances, frequency bands

Characteristics of selected wireless links

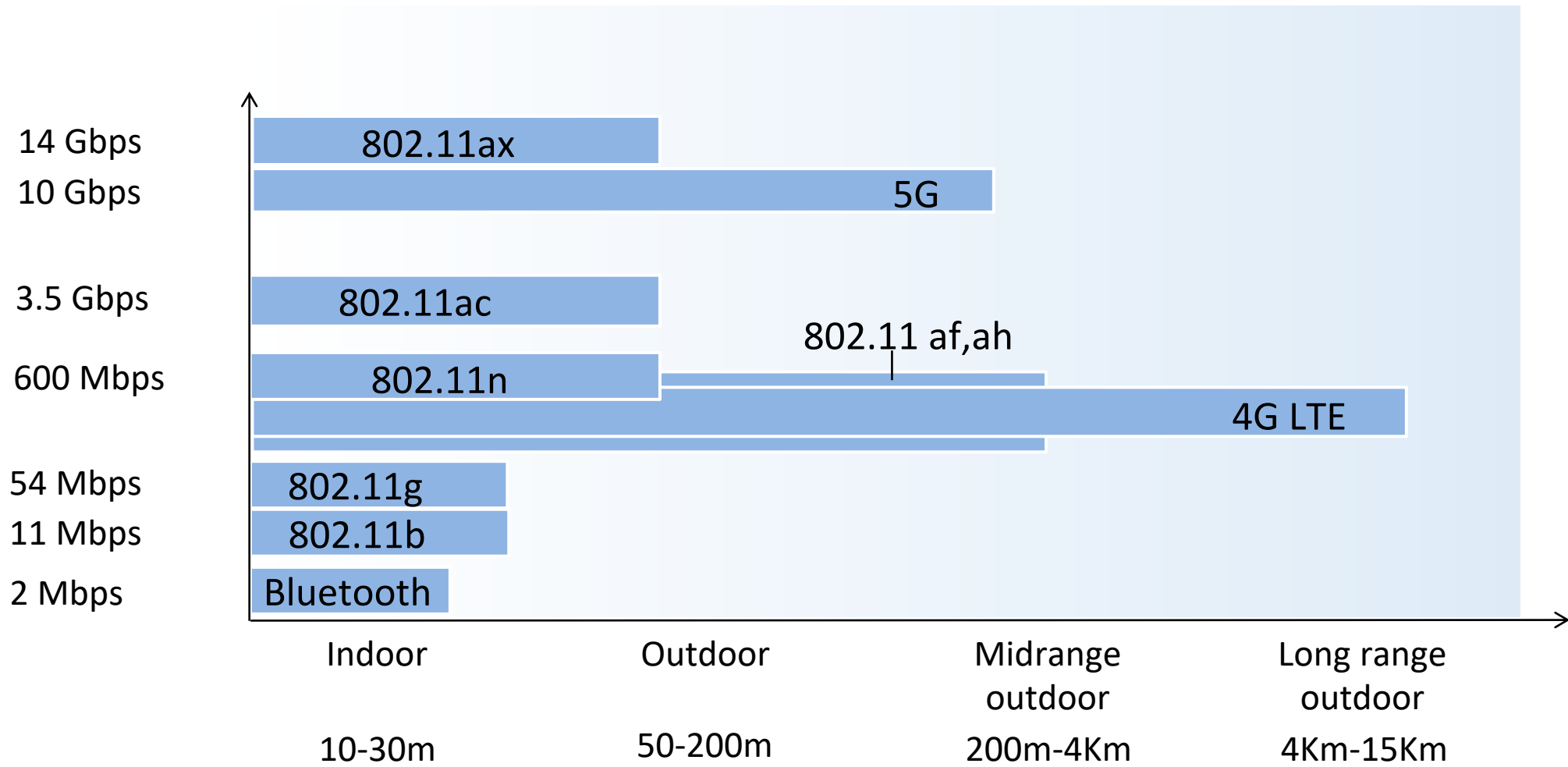

Elements of a wireless network

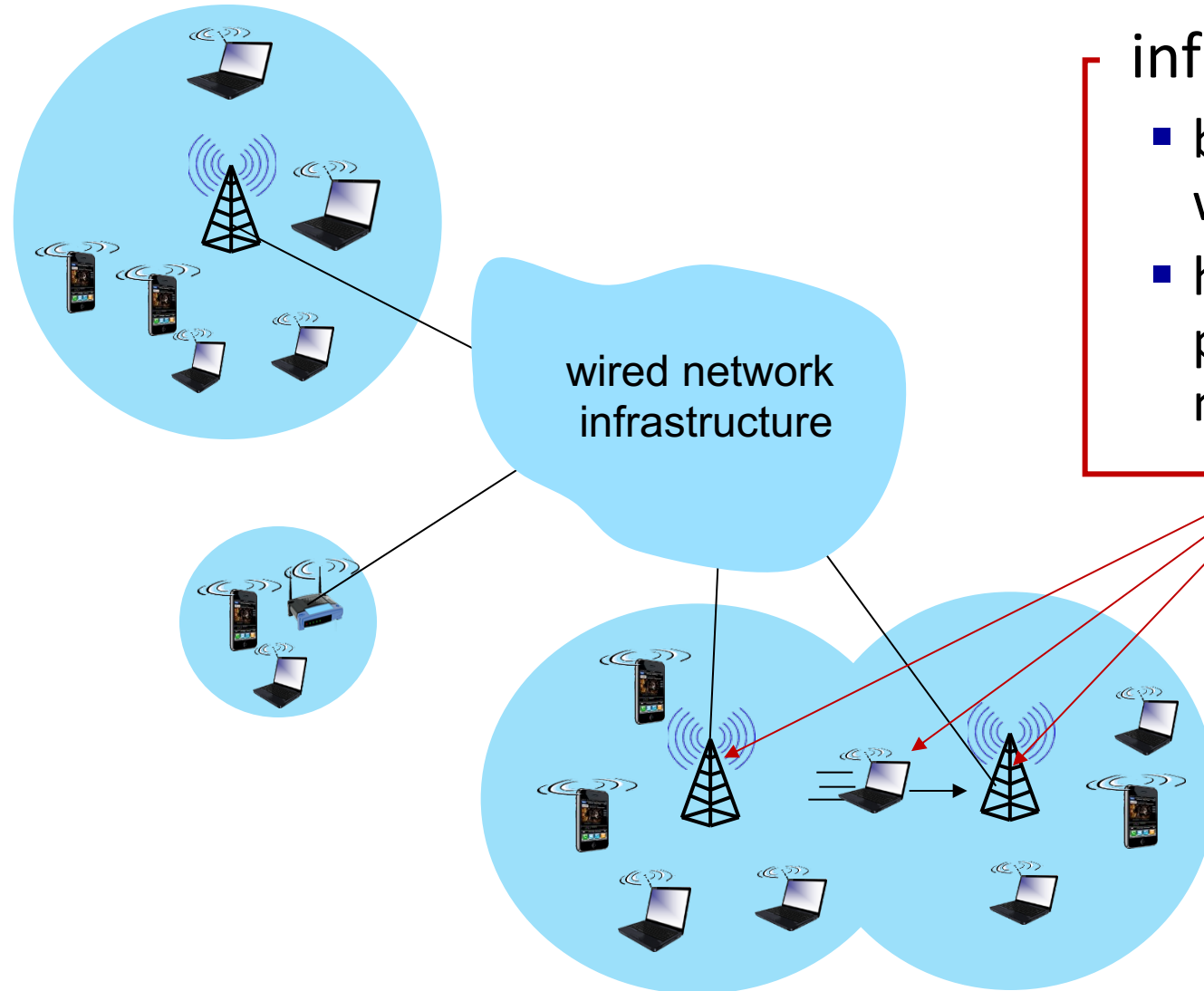

infrastructure mode

- base station connects mobiles into wired network
- handoff: mobile changes base station providing connection into wired network

Elements of a wireless network

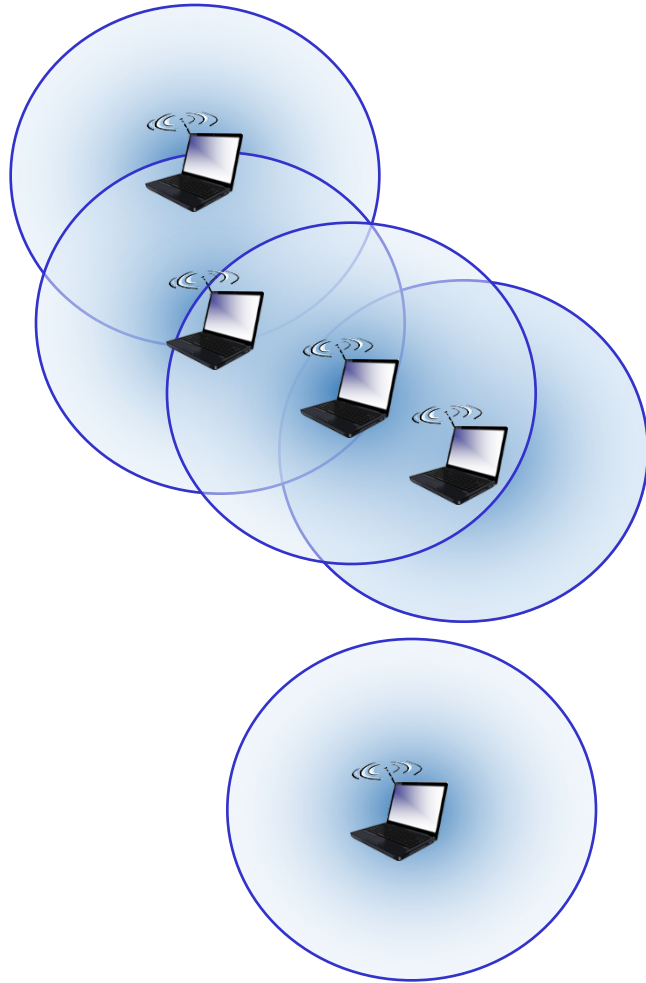

ad hoc mode

- no base stations
- nodes can only transmit to other nodes within link coverage
- nodes organize themselves into a network: route among themselves

Wireless network taxonomy

	single hop	multiple hops
infrastructure (e.g., APs)	host connects to base station (WiFi, cellular) which connects to larger Internet	host may have to relay through several wireless nodes to connect to larger Internet: <i>mesh net</i>
<i>no infrastructure</i>	no base station, no connection to larger Internet (Bluetooth, ad hoc nets)	no base station, no connection to larger Internet. May have to relay to reach other a given wireless node MANET, VANET

Chapter 7 outline

- Introduction

Wireless

- Wireless links and network characteristics
- WiFi: 802.11 wireless LANs
- Cellular networks: 4G and 5G



Mobility

- Mobility management: principles
- Mobility management: practice
 - 4G/5G networks
 - Mobile IP
- Mobility: impact on higher-layer protocols

Wireless link characteristics (1)

important differences from wired link

- **decreased signal strength:** radio signal attenuates as it propagates through matter (path loss)
- **interference from other sources:** wireless network frequencies (e.g., 2.4 GHz) shared by many devices (e.g., WiFi, cellular, motors): interference
- **multipath propagation:** radio signal reflects off objects ground, arriving at destination at slightly different times

.... make communication across (even a point to point) wireless link much more “difficult”



Wireless link characteristics (2)

- SNR: signal-to-noise ratio
 - larger SNR – easier to extract signal from noise (a “good thing”)
- SNR versus BER tradeoffs
 - *given physical layer*: increase power -> increase SNR->decrease BER
 - *given SNR*: choose physical layer that meets BER requirement, giving highest throughput
 - SNR may change with mobility: dynamically adapt physical layer (modulation technique, rate)

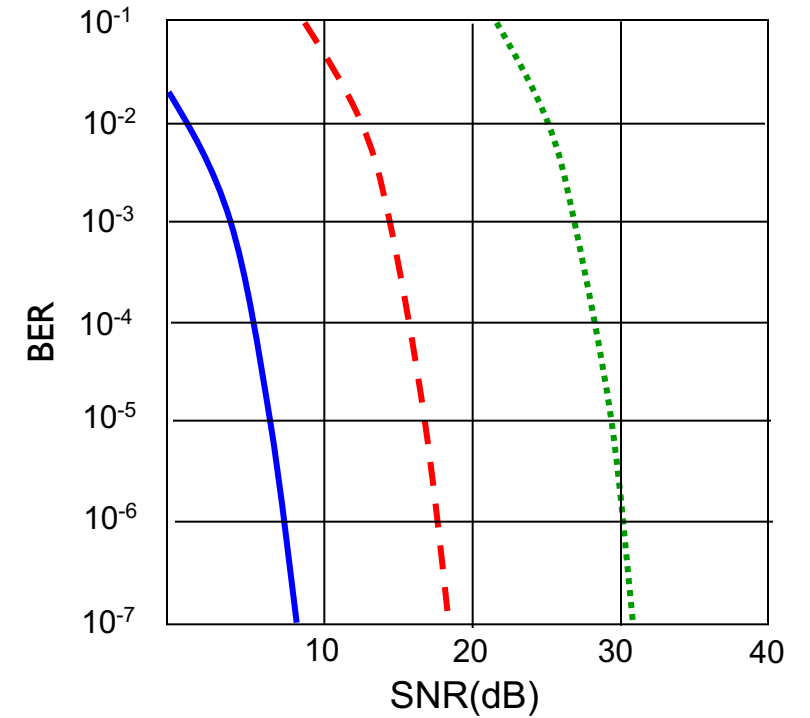

- QAM256 (8 Mbps)
- - - QAM16 (4 Mbps)
- BPSK (1 Mbps)

Wireless link characteristics (3)

Multiple wireless senders, receivers create additional problems (beyond multiple access):

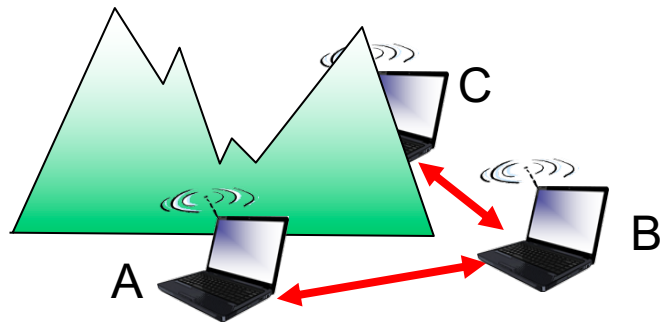

Hidden terminal problem

- B, A hear each other
- B, C hear each other
- A, C can not hear each other means A, C unaware of their interference at B

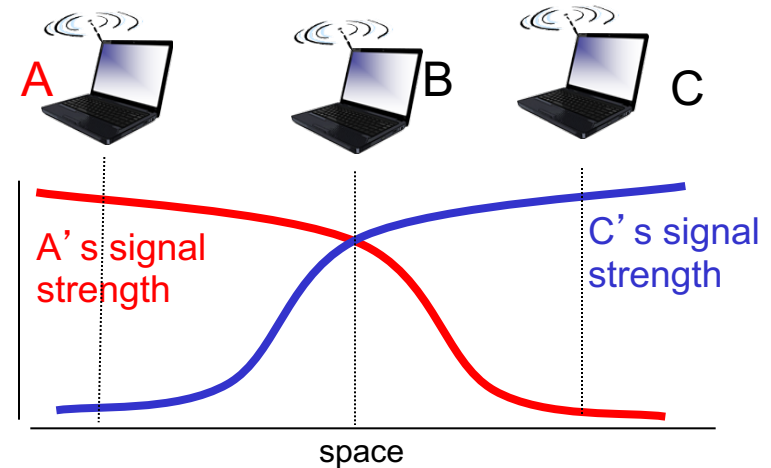

Signal attenuation:

- B, A hear each other
- B, C hear each other
- A, C can not hear each other interfering at B

Code Division Multiple Access (CDMA)

- unique “code” assigned to each user; i.e., code set partitioning
 - all users share same frequency, but each user has own “chipping” sequence (i.e., code) to encode data
 - allows multiple users to “coexist” and transmit simultaneously with minimal interference (if codes are “orthogonal”)
- **encoding:** inner product: (original data) X (chipping sequence)
- **decoding:** summed inner-product: (encoded data) X (chipping sequence)

CDMA encode/decode

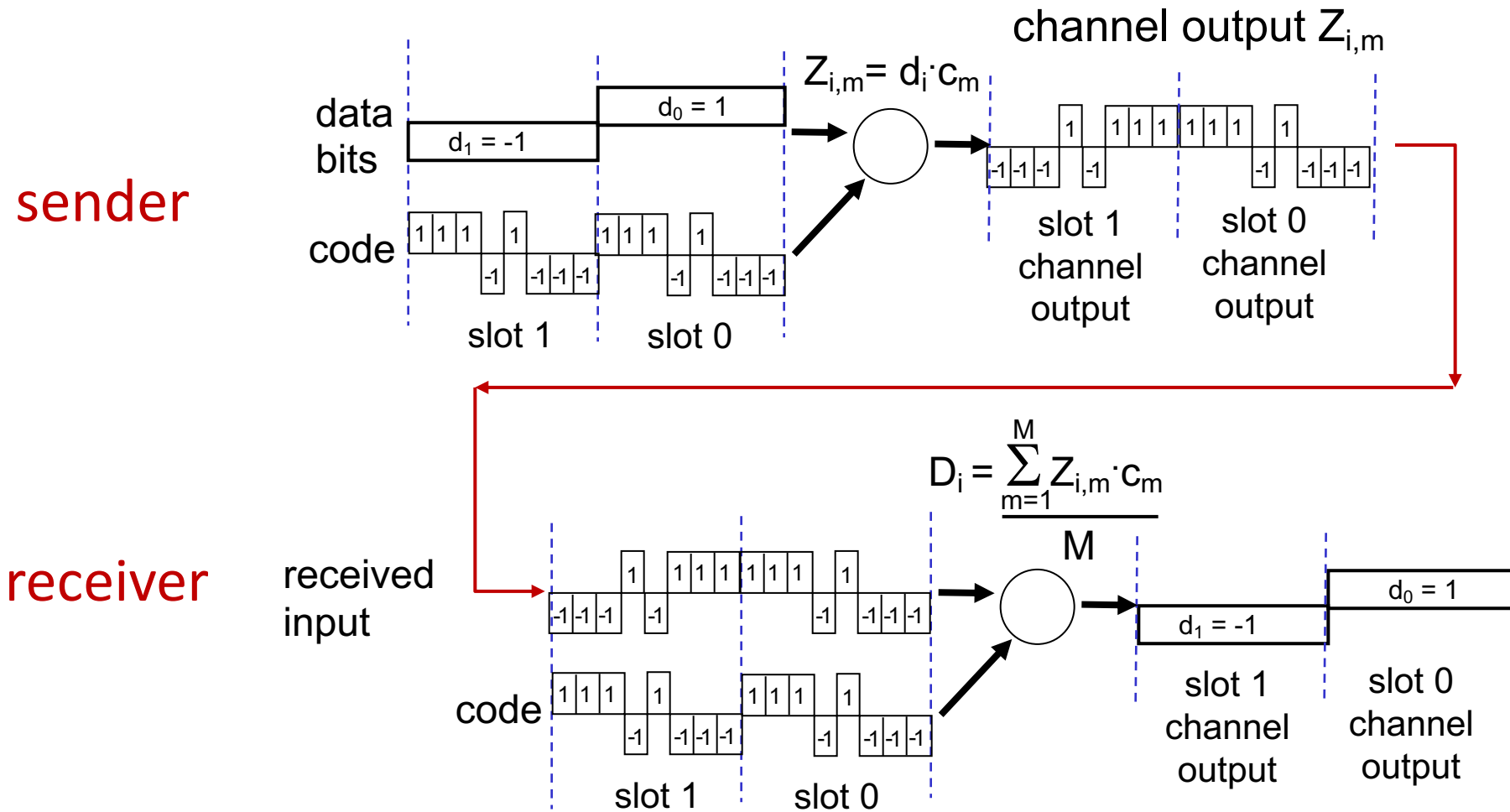

... but this isn't really useful yet!

CDMA: two-sender interference

Sender 1

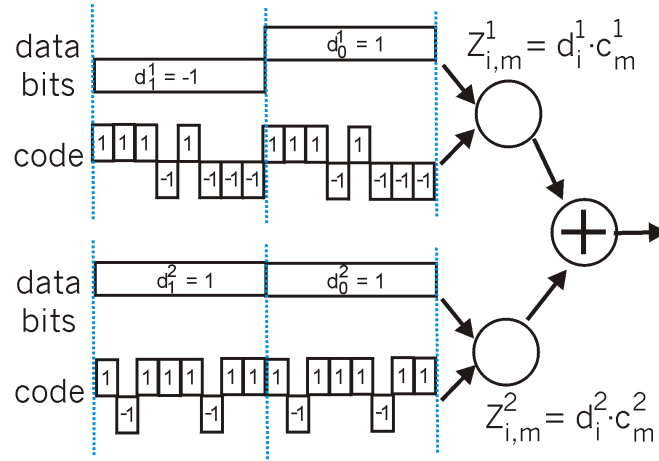

Sender 2

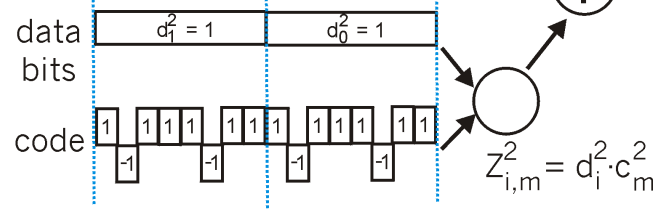

channel sums together transmissions by sender 1 and 2

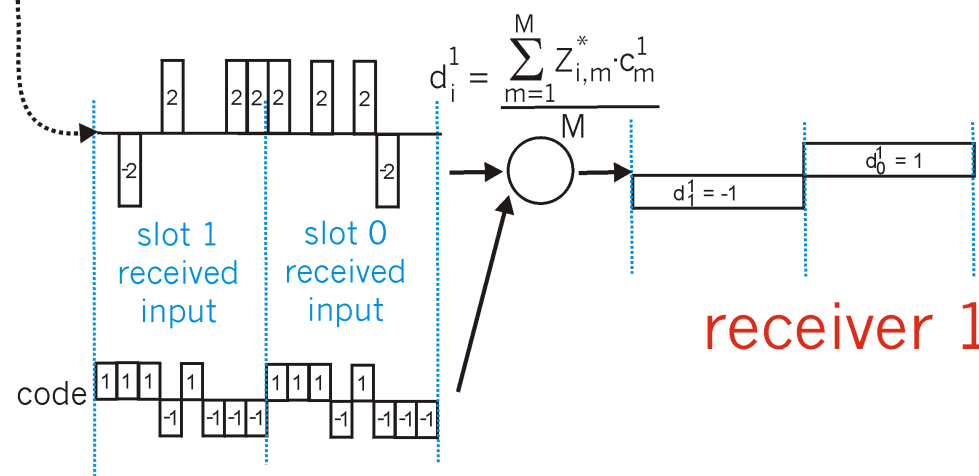
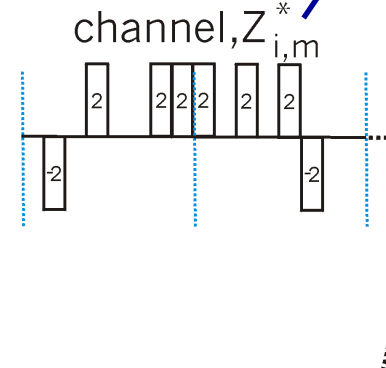

using same code as sender 1, receiver recovers sender 1's original data from summed channel data!

... now *that's* useful!

Chapter 7 outline

- Introduction

Wireless

- Wireless links and network characteristics
- **WiFi: 802.11 wireless LANs**
- Cellular networks: 4G and 5G

Mobility

- Mobility management: principles
- Mobility management: practice
 - 4G/5G networks
 - Mobile IP
- Mobility: impact on higher-layer protocols



IEEE 802.11 Wireless LAN

IEEE 802.11 standard	Year	Max data rate	Range	Frequency
802.11b	1999	11 Mbps	30 m	2.4 Ghz
802.11g	2003	54 Mbps	30m	2.4 Ghz
802.11n (WiFi 4)	2009	600	70m	2.4, 5 Ghz
802.11ac (WiFi 5)	2013	3.47Gpbs	70m	5 Ghz
802.11ax (WiFi 6)	2020 (exp.)	14 Gbps	70m	2.4, 5 Ghz
802.11af	2014	35 – 560 Mbps	1 Km	unused TV bands (54-790 MHz)
802.11ah	2017	347Mbps	1 Km	900 Mhz

- all use CSMA/CA for multiple access, and have base-station and ad-hoc network versions

802.11 LAN architecture

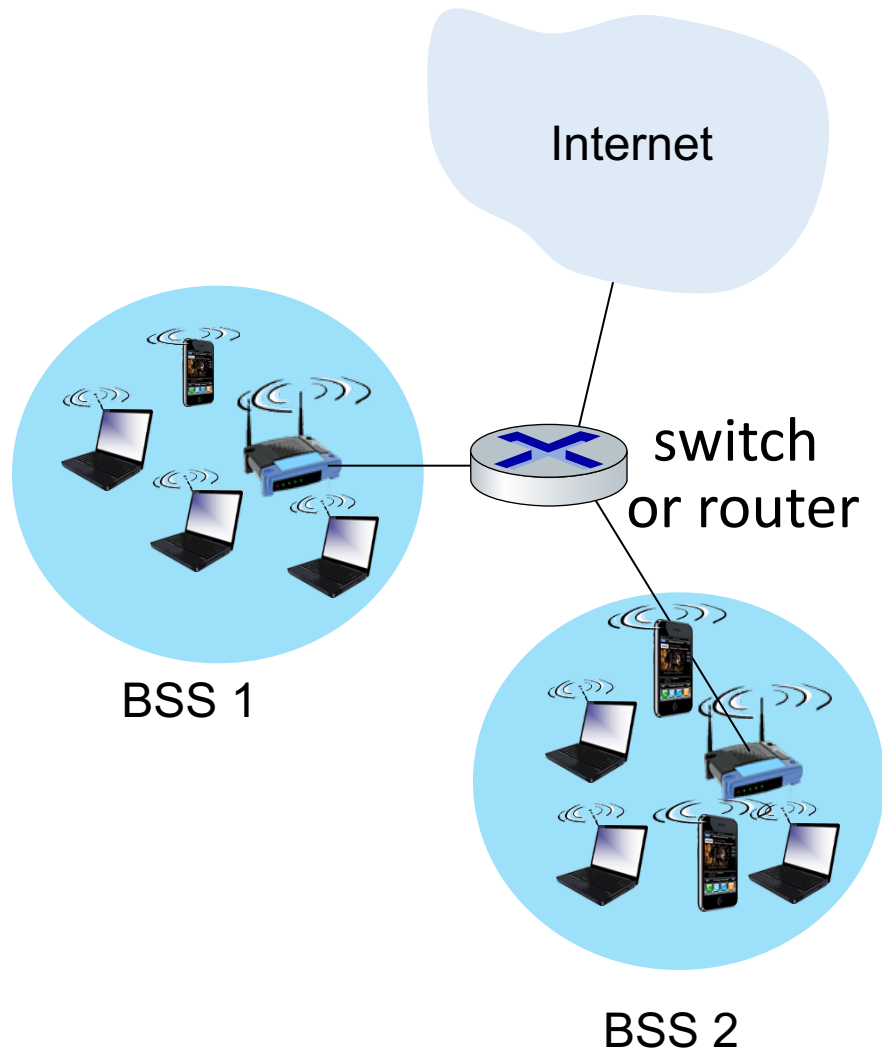

- wireless host communicates with base station
 - base station = access point (AP)
- Basic Service Set (BSS) (aka “cell”) in infrastructure mode contains:
 - wireless hosts
 - access point (AP): base station
 - ad hoc mode: hosts only

802.11: Channels, association

- spectrum divided into channels at different frequencies
 - AP admin chooses frequency for AP
 - interference possible: channel can be same as that chosen by neighboring AP!
- arriving host: must **associate** with an AP
 - scans channels, listening for *beacon frames* containing AP's name (SSID) and MAC address
 - selects AP to associate with
 - then may perform authentication [Chapter 8]
 - then typically run DHCP to get IP address in AP's subnet



802.11: passive/active scanning

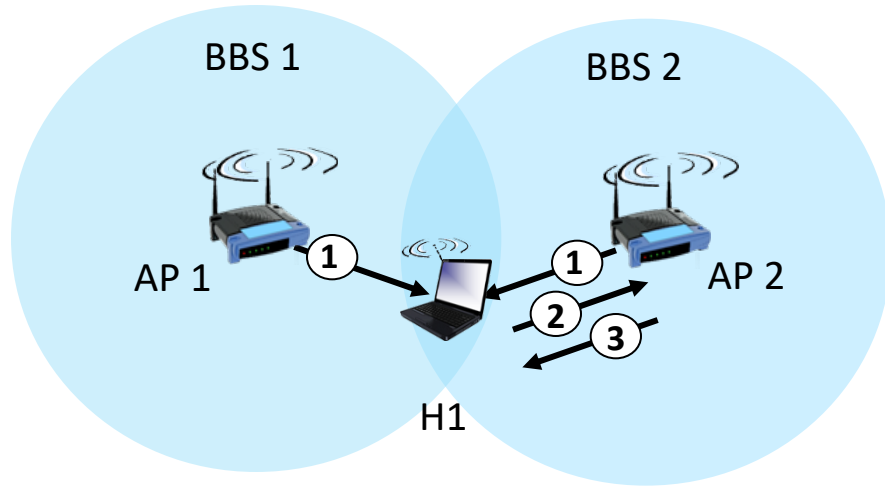

passive scanning:

- (1) beacon frames sent from APs
- (2) association Request frame sent: H1 to selected AP
- (3) association Response frame sent from selected AP to H1

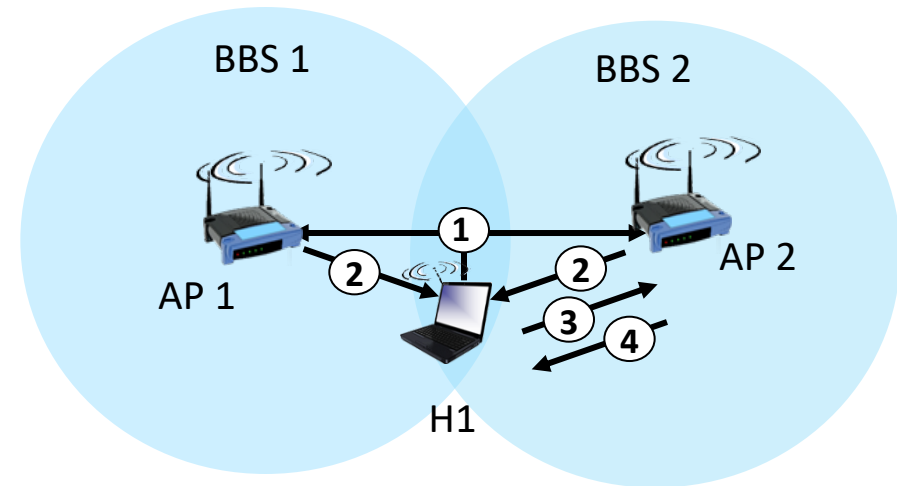

active scanning:

- (1) Probe Request frame broadcast from H1
- (2) Probe Response frames sent from APs
- (3) Association Request frame sent: H1 to selected AP
- (4) Association Response frame sent from selected AP to H1

IEEE 802.11: multiple access

- avoid collisions: 2+ nodes transmitting at same time
- 802.11: CSMA - sense before transmitting
 - don't collide with detected ongoing transmission by another node
- 802.11: *no* collision detection!
 - difficult to sense collisions: high transmitting signal, weak received signal due to fading
 - can't sense all collisions in any case: hidden terminal, fading
 - goal: *avoid collisions*: CSMA/CollisionAvoidance

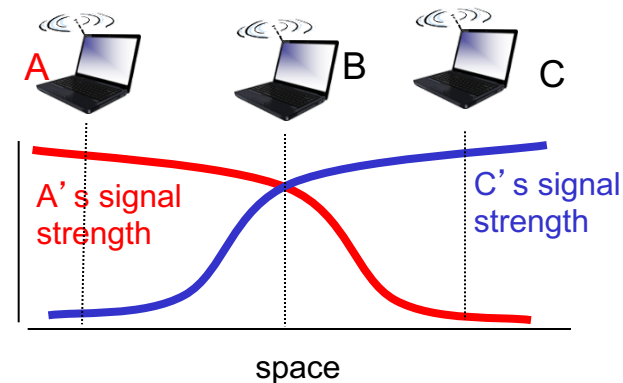
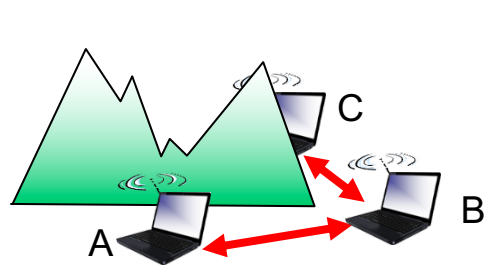

IEEE 802.11 MAC Protocol: CSMA/CA

802.11 sender

- 1 if sense channel idle for **DIFS** then transmit entire frame (no CD)
- 2 if sense channel busy then start random backoff time
timer counts down while channel idle
transmit when timer expires
if no ACK, increase random backoff interval, repeat 2

802.11 receiver

- if frame received OK
return ACK after **SIFS** (ACK needed due to hidden terminal problem)

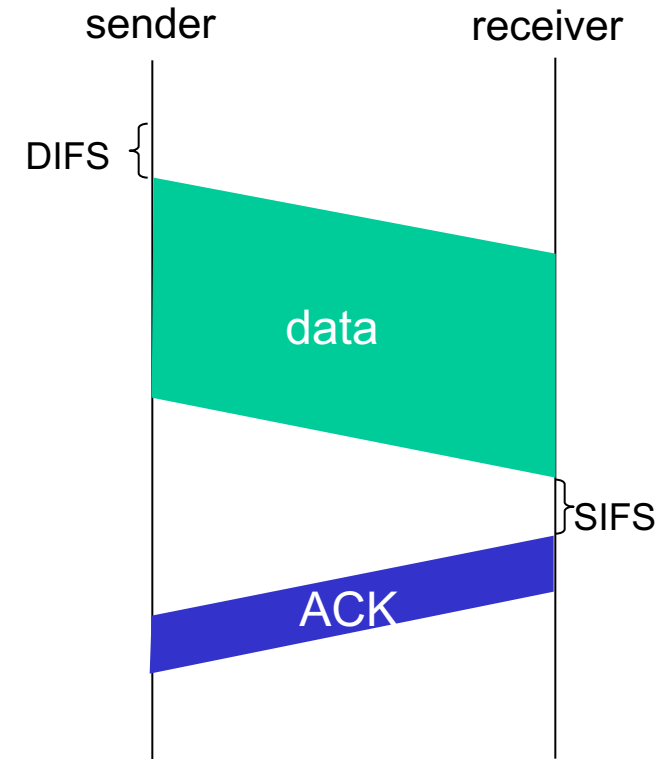

Avoiding collisions (more)

idea: sender “reserves” channel use for data frames using small reservation packets

- sender first transmits *small* request-to-send (RTS) packet to BS using CSMA
 - RTSs may still collide with each other (but they’re short)
- BS broadcasts clear-to-send CTS in response to RTS
- CTS heard by all nodes
 - sender transmits data frame
 - other stations defer transmissions

Collision Avoidance: RTS-CTS exchange

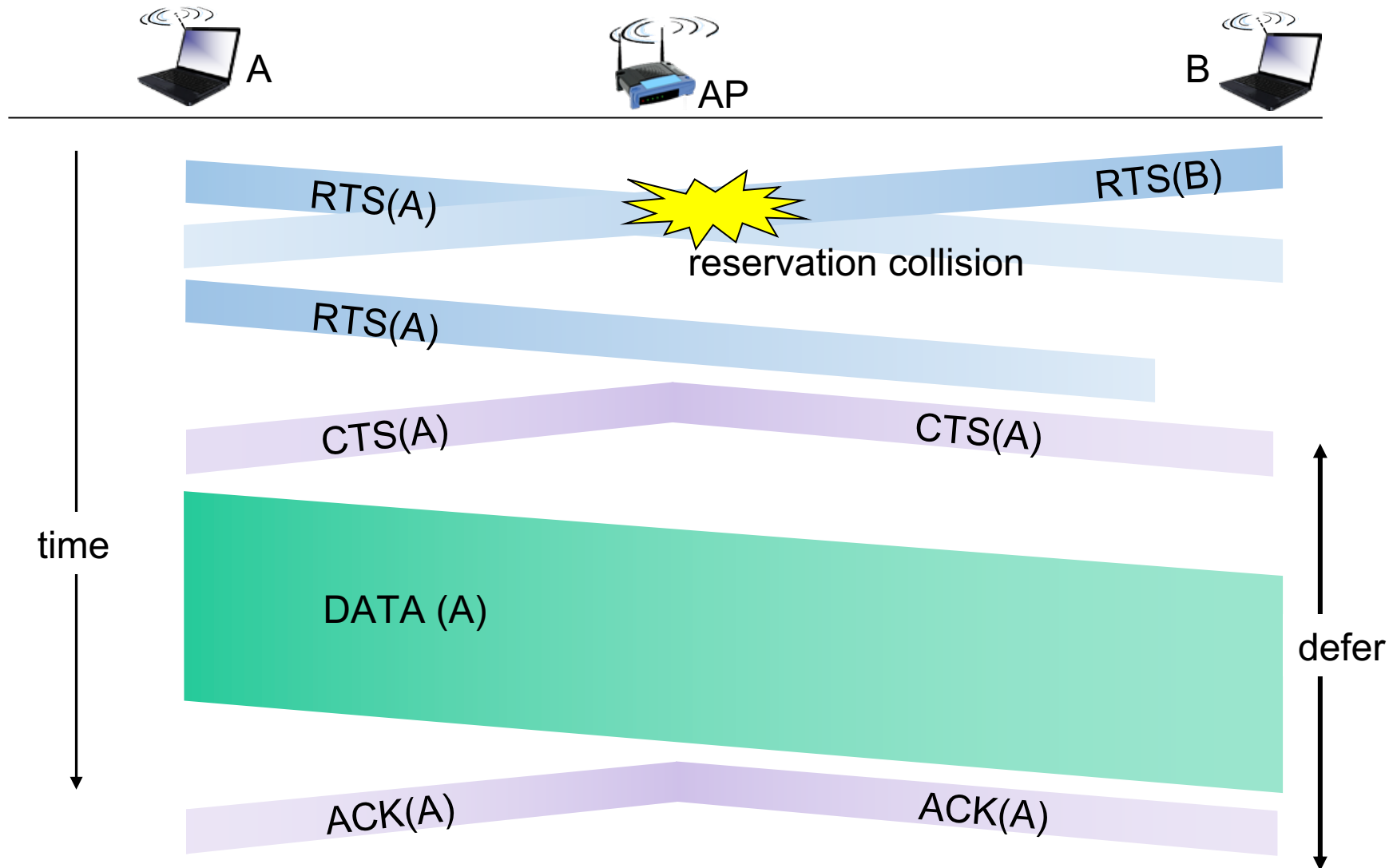

802.11 frame: addressing

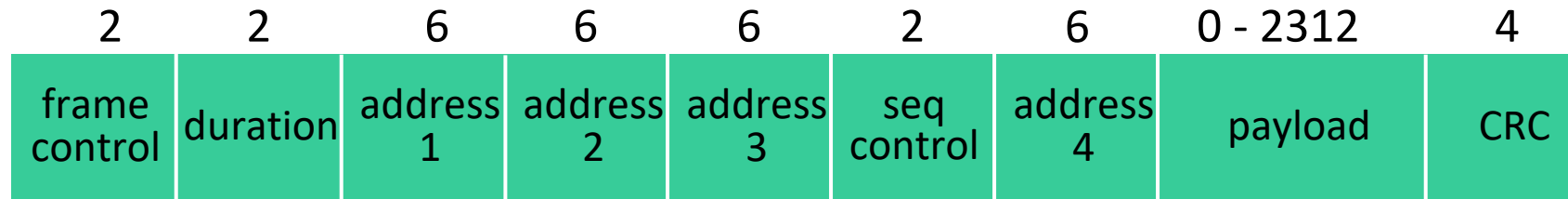

Address 1: MAC address of wireless host or AP to receive this frame

Address 2: MAC address of wireless host or AP transmitting this frame

Address 3: MAC address of router interface to which AP is attached

Address 4: used only in ad hoc mode

802.11 frame: addressing

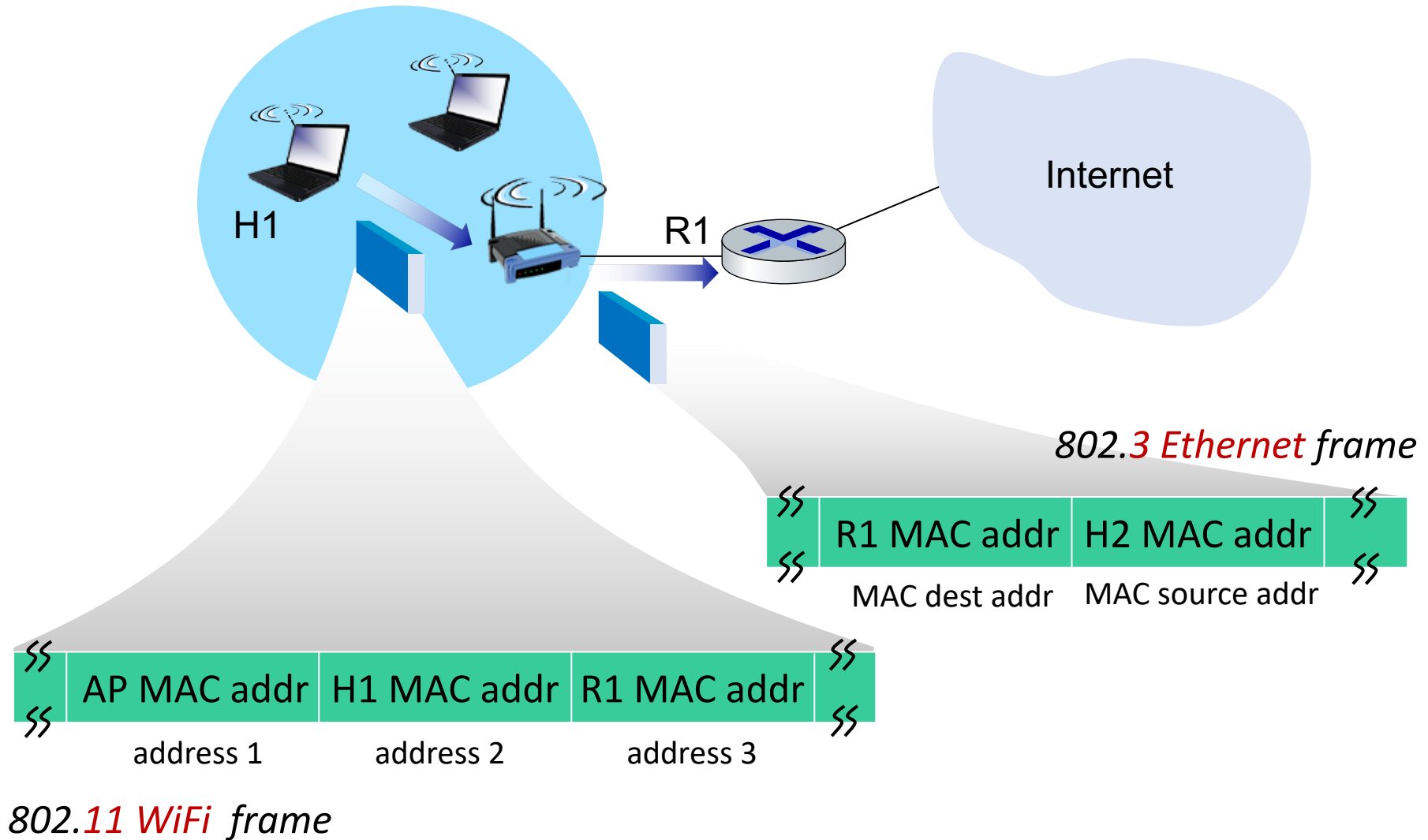

802.11 frame: addressing

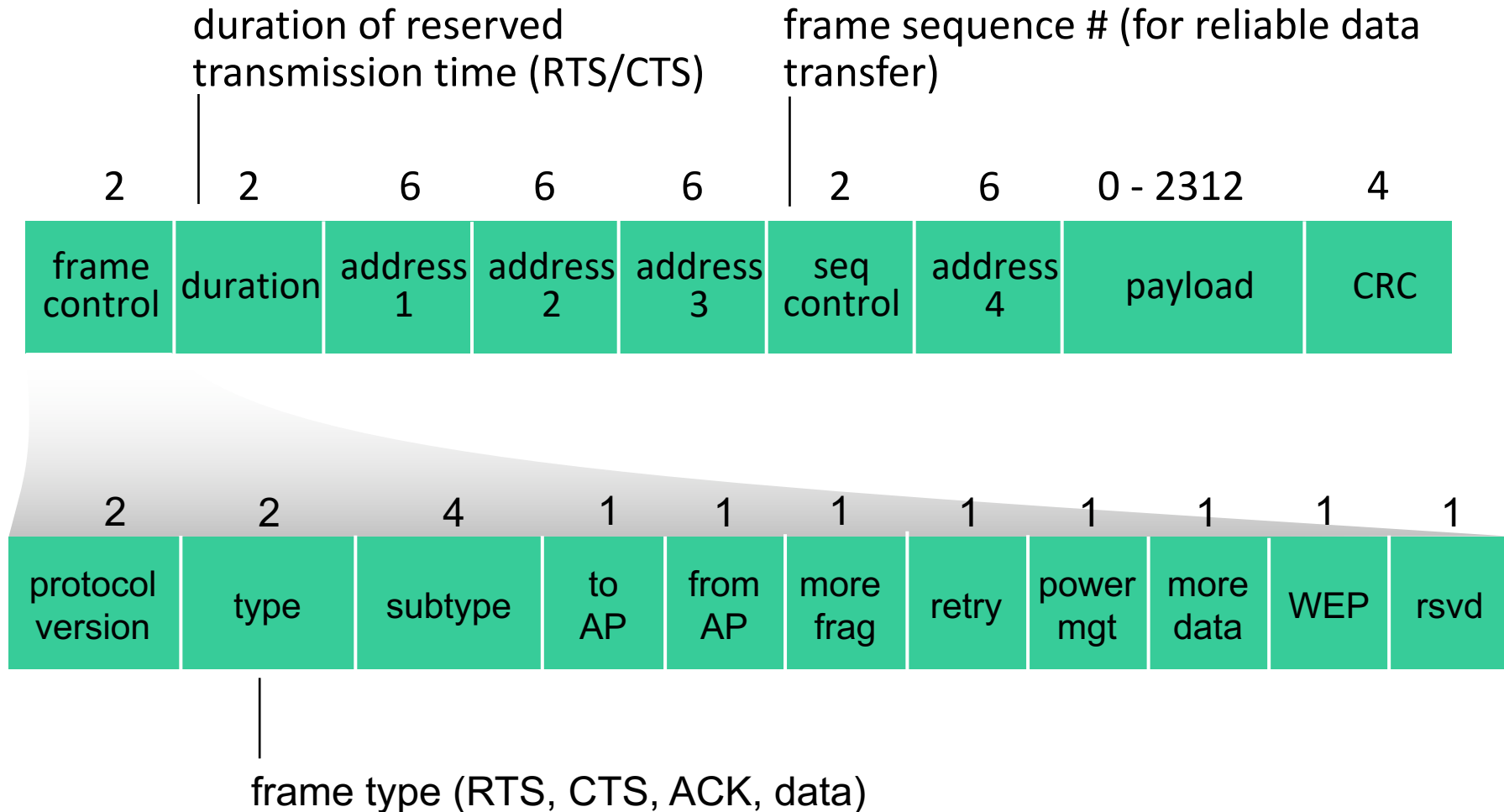

802.11: mobility within same subnet

- H1 remains in same IP subnet: IP address can remain same
- switch: which AP is associated with H1?
 - self-learning (Ch. 6): switch will see frame from H1 and “remember” which switch port can be used to reach H1

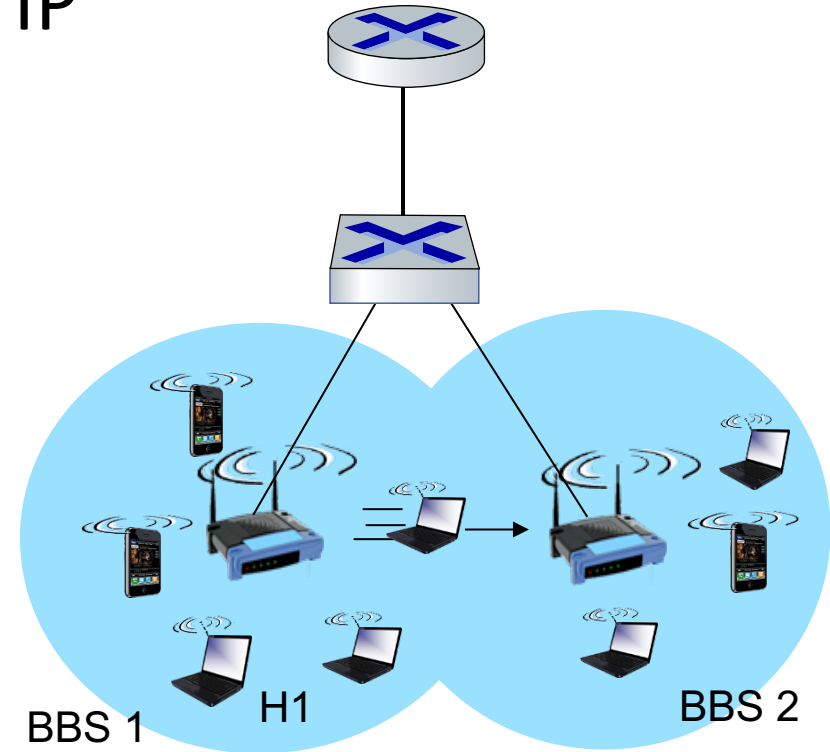

802.11: advanced capabilities

Rate adaptation

- base station, mobile dynamically change transmission rate (physical layer modulation technique) as mobile moves, SNR varies
 1. SNR decreases, BER increase as node moves away from base station
 2. When BER becomes too high, switch to lower transmission rate but with lower BER

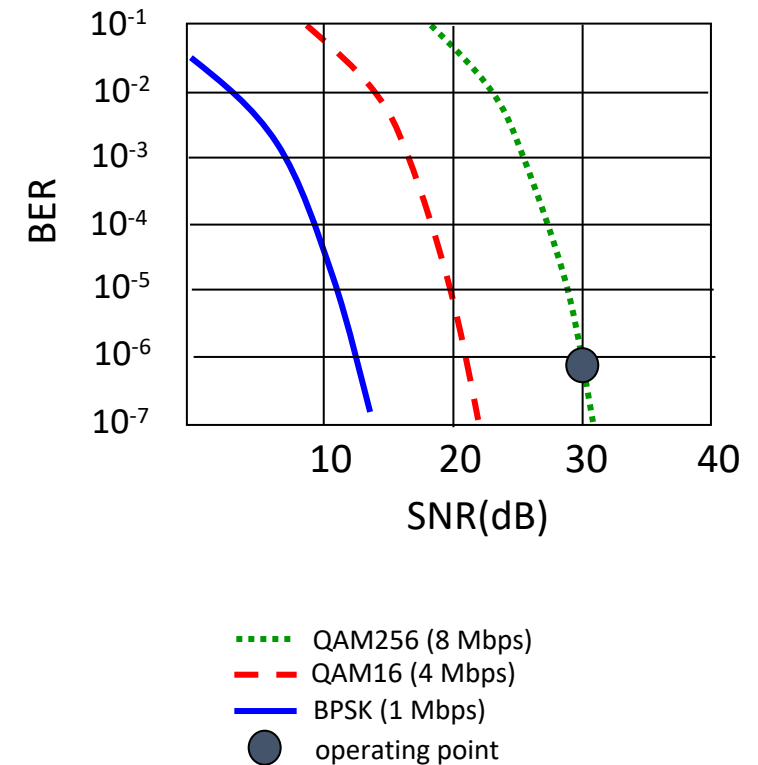

802.11: advanced capabilities

power management

- node-to-AP: “I am going to sleep until next beacon frame”
 - AP knows not to transmit frames to this node
 - node wakes up before next beacon frame
- beacon frame: contains list of mobiles with AP-to-mobile frames waiting to be sent
 - node will stay awake if AP-to-mobile frames to be sent; otherwise sleep again until next beacon frame

Personal area networks: Bluetooth

- less than 10 m diameter
- replacement for cables (mouse, keyboard, headphones)
- ad hoc: no infrastructure
- 2.4-2.5 GHz ISM radio band, up to 3 Mbps
- master controller / clients devices:
 - master polls clients, grants requests for client transmissions

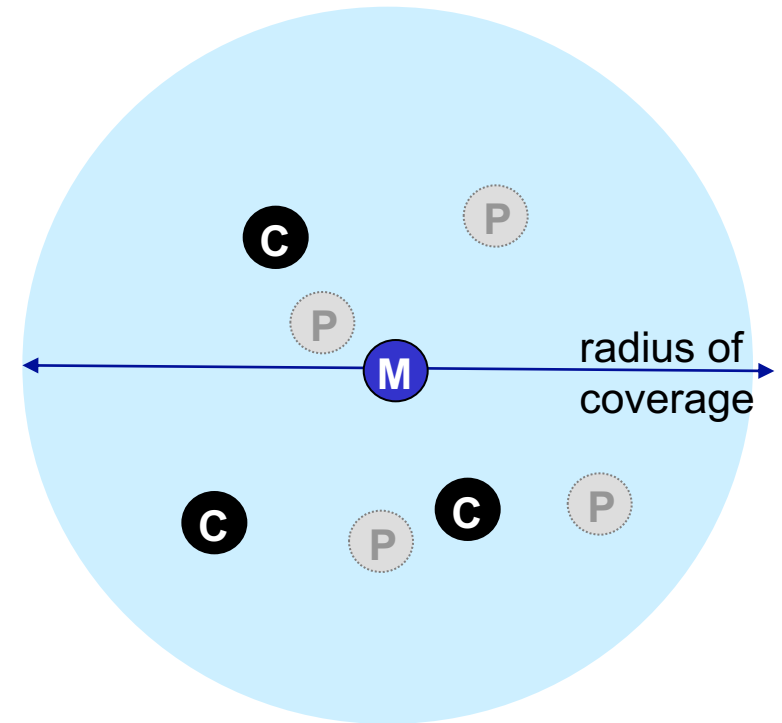

- M** master device
- C** client device
- P** parked device (inactive)

Personal area networks: Bluetooth

- TDM, 625 μ sec sec. slot
- FDM: sender uses 79 frequency channels in known, pseudo-random order slot-to-slot (spread spectrum)
 - other devices/equipment not in piconet only interfere in some slots
- **parked mode:** clients can “go to sleep” (park) and later wakeup (to preserve battery)
- **bootstrapping:** nodes self-assemble (plug and play) into piconet

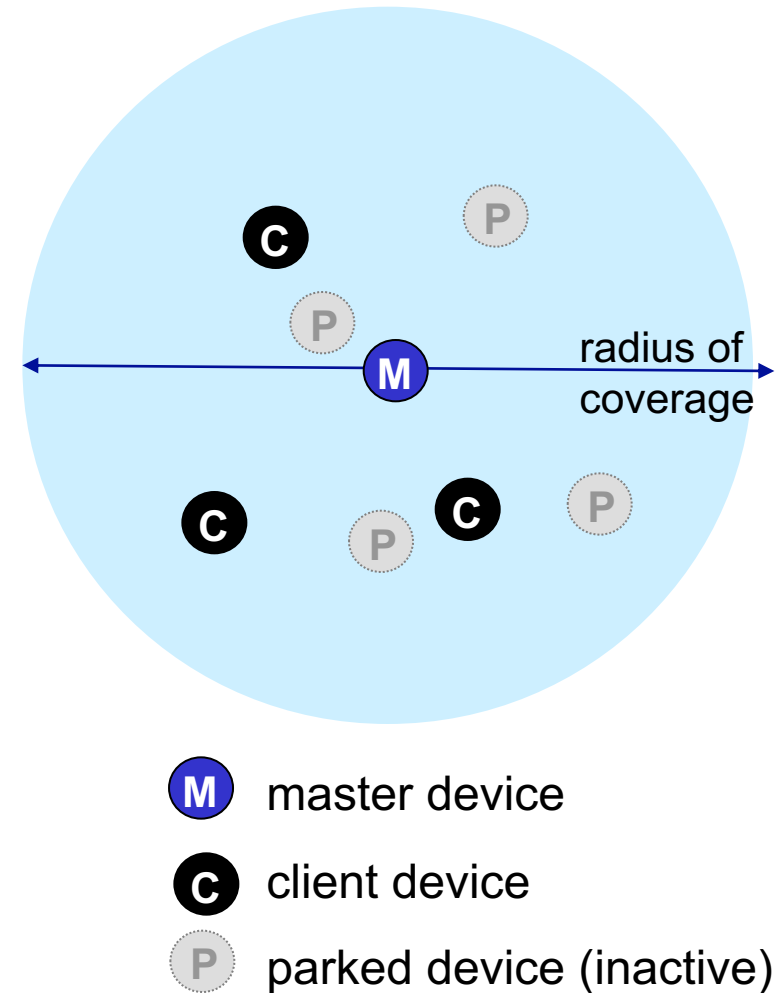

Chapter 7 outline

- Introduction

Wireless

- Wireless links and network characteristics
- WiFi: 802.11 wireless LANs
- Cellular networks: 4G and 5G



Mobility

- Mobility management: principles
- Mobility management: practice
 - 4G/5G networks
 - Mobile IP
- Mobility: impact on higher-layer protocols

4G/5G cellular networks

- *the* solution for wide-area mobile Internet
- widespread deployment/use:
 - more mobile-broadband-connected devices than fixed-broadband-connected devices (5-1 in 2019)!
 - 4G availability: 97% of time in Korea (90% in US)
- transmission rates up to 100's Mbps
- technical standards: 3rd Generation Partnership Project (3GPP)
 - www.3gpp.org
 - 4G: Long-Term Evolution (LTE) standard

4G/5G cellular networks

similarities to wired Internet

- edge/core distinction, but both below to same carrier
- global cellular network: a network of networks
- widespread use of protocols we've studied: HTTP, DNS, TCP, UDP, IP, NAT, separation of data/control planes, SDN, Ethernet, tunneling
- interconnected to wired Internet

differences from wired Internet

- different wireless link layer
- mobility as a 1st class service
- user “identity” (via SIM card)
- business model: users subscribe to a cellular provider
 - strong notion of “home network” versus roaming on visited nets
 - global access, with authentication infrastructure, and inter-carrier settlements

Elements of 4G LTE architecture

Mobile device:

- smartphone, tablet, laptop, IoT, ... with 4G LTE radio
- 64-bit International Mobile Subscriber Identity (IMSI), stored on SIM (Subscriber Identity Module) card
- LTE jargon: User Equipment (UE)

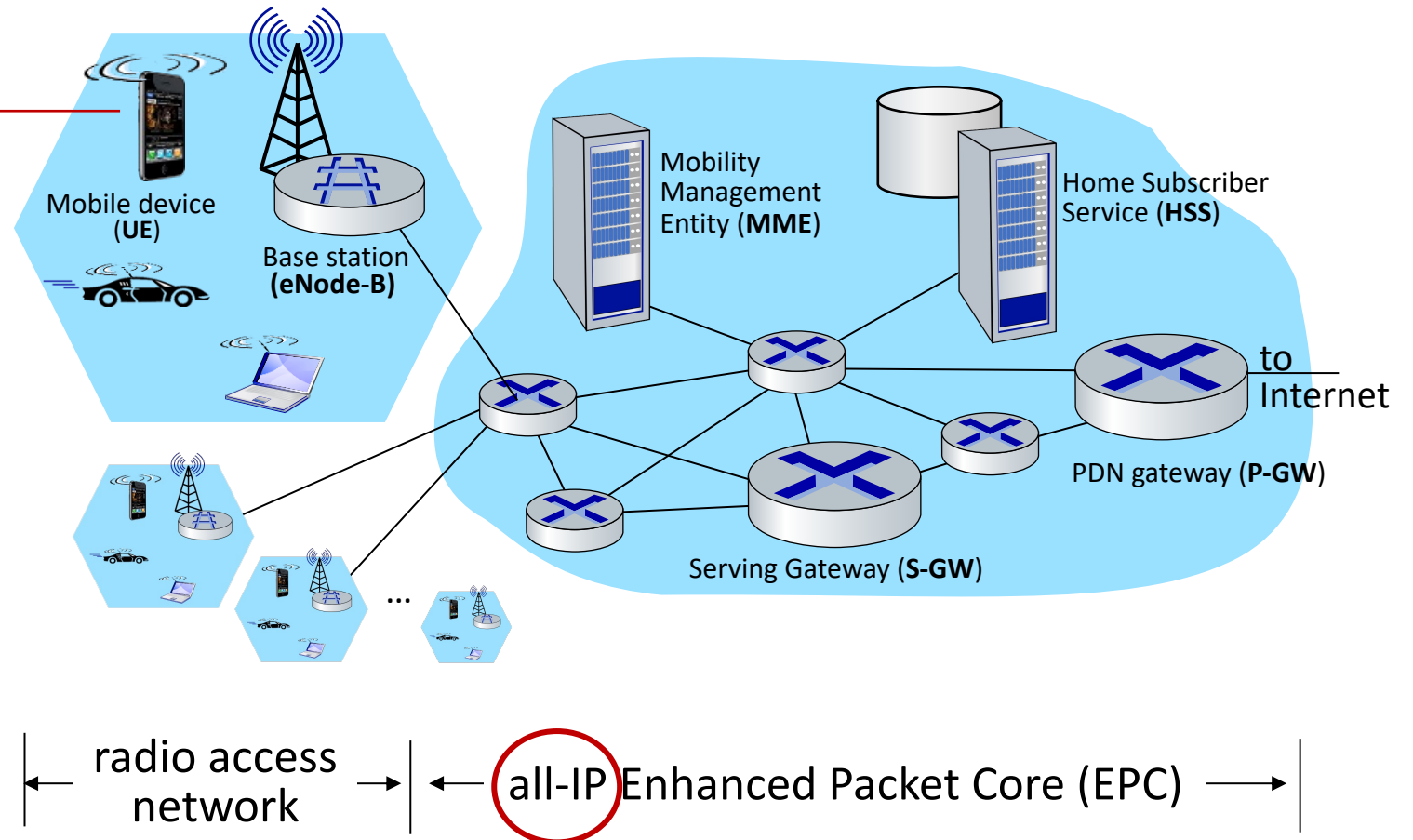

Elements of 4G LTE architecture

Base station:

- at “edge” of carrier’s network
- manages wireless radio resources, mobile devices in its coverage area (“cell”)
- coordinates device authentication with other elements
- similar to WiFi AP but:
 - active role in user mobility
 - coordinates with nearby base stations to optimize radio use
- LTE jargon: eNode-B

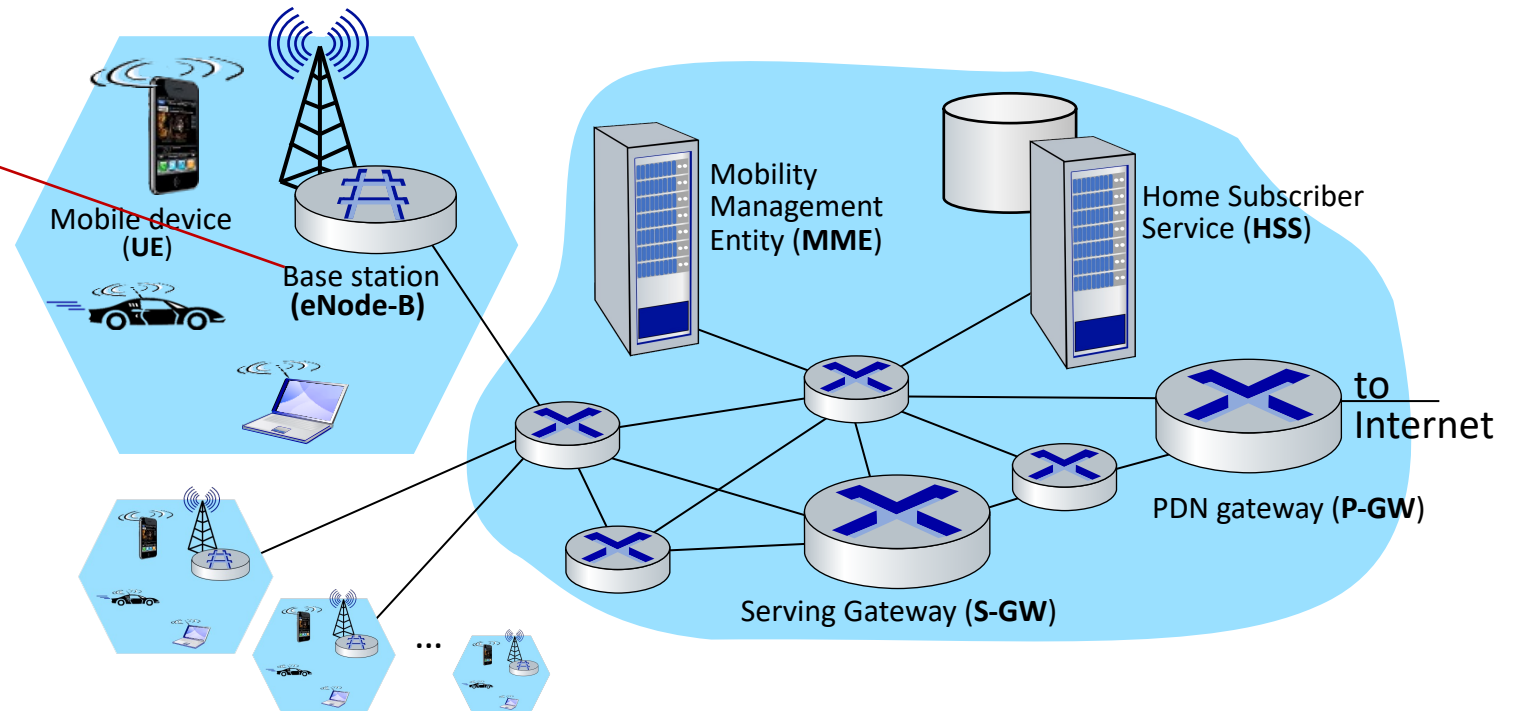

Elements of 4G LTE architecture

Home Subscriber Service

- stores info about mobile devices for which the HSS's network is their "home network"
- works with MME in device authentication

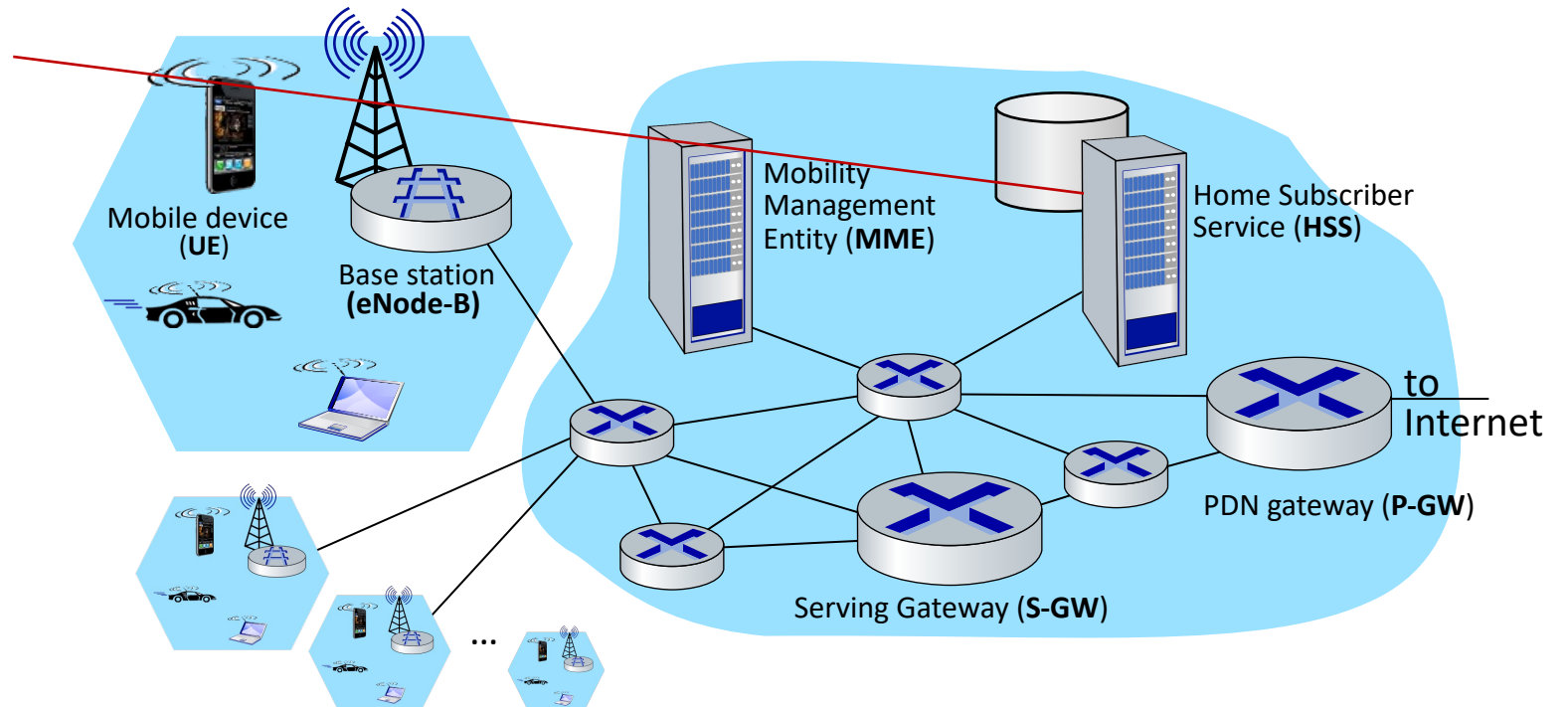

Elements of 4G LTE architecture

Serving Gateway (S-GW), PDN Gateway (P-GW)

- lie on data path from mobile to/from Internet
- P-GW
 - gateway to mobile cellular network
 - Looks like any other internet gateway router
 - provides NAT services
- other routers:
 - extensive use of tunneling

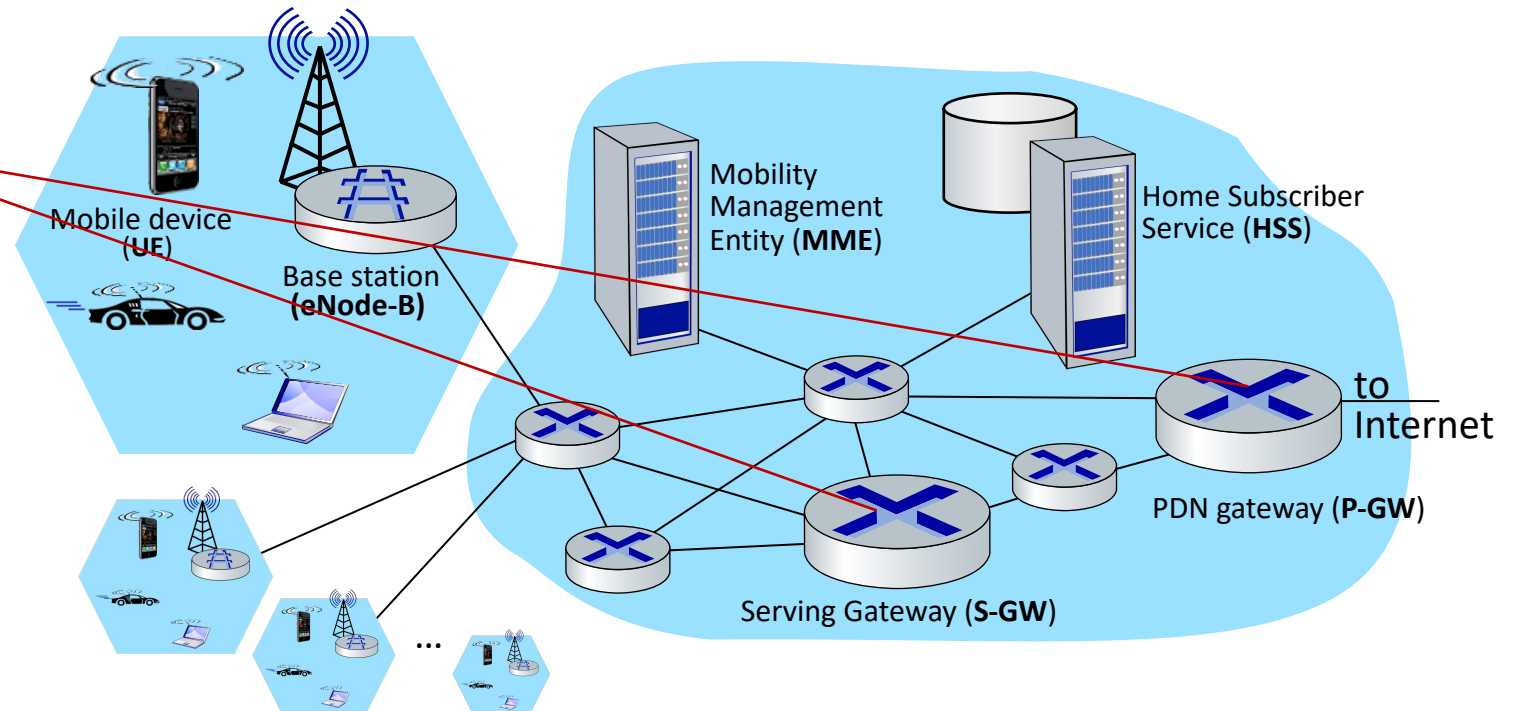

Elements of 4G LTE architecture

Mobility Management Entity

- device authentication (device-to-network, network-to-device) coordinated with mobile home network HSS
- mobile device management:
 - device handover between cells
 - tracking/paging device location
- path (tunneling) setup from mobile device to P-GW

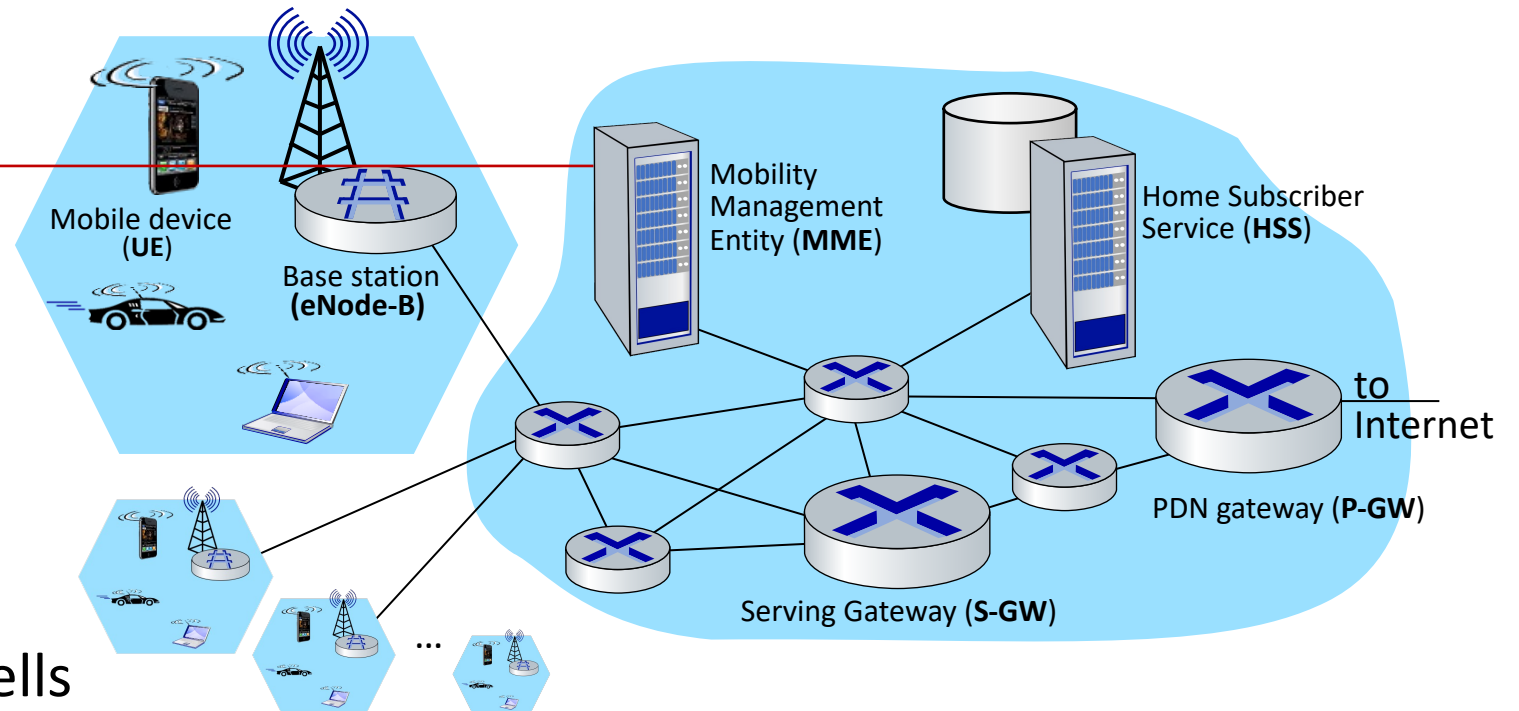

LTE: data plane control plane separation

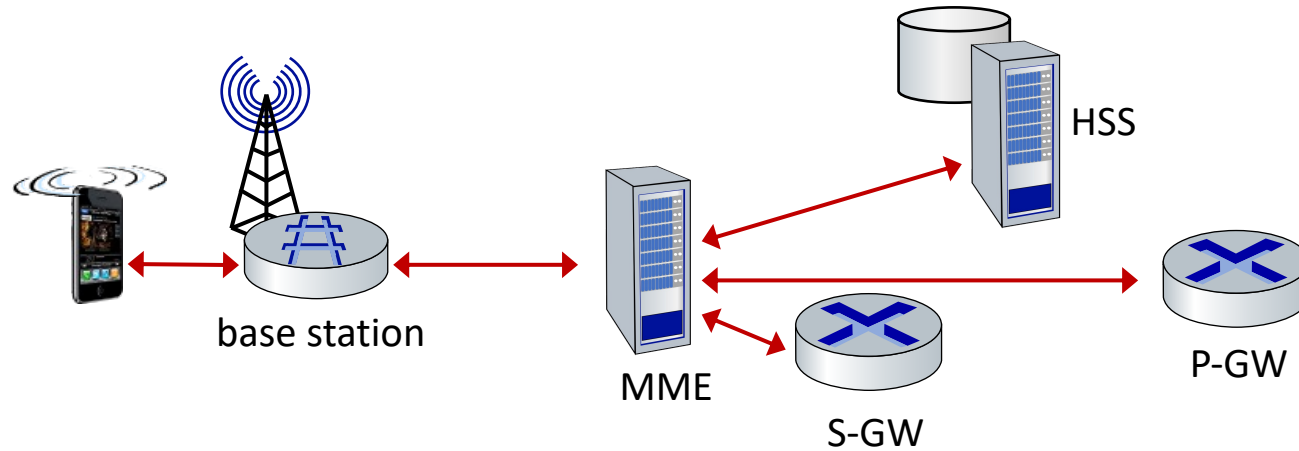

control plane

- new protocols for mobility management, security, authentication (later)

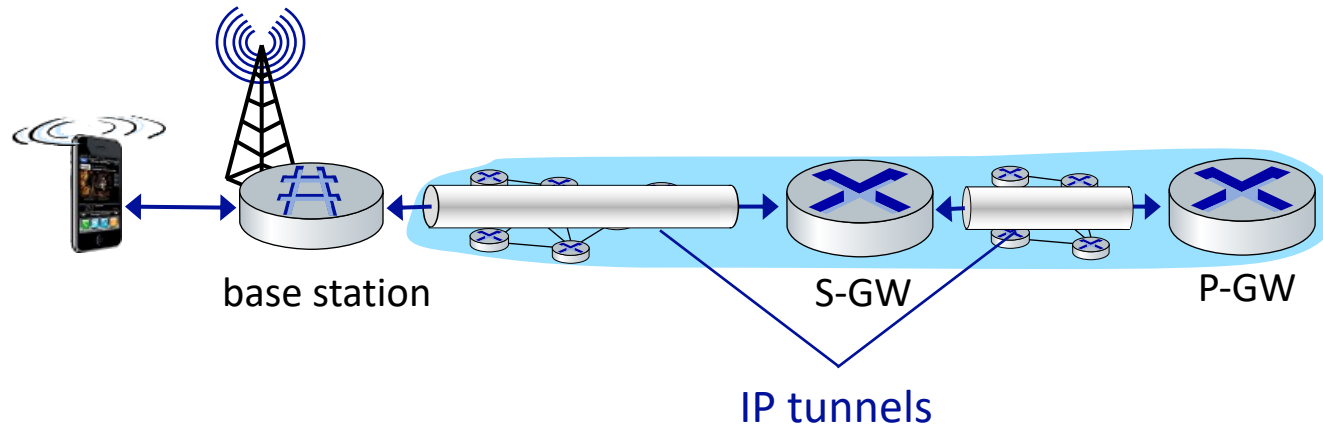

data plane

- new protocols at link, physical layers
- extensive use of tunneling to facilitate mobility

LTE data plane protocol stack: first hop

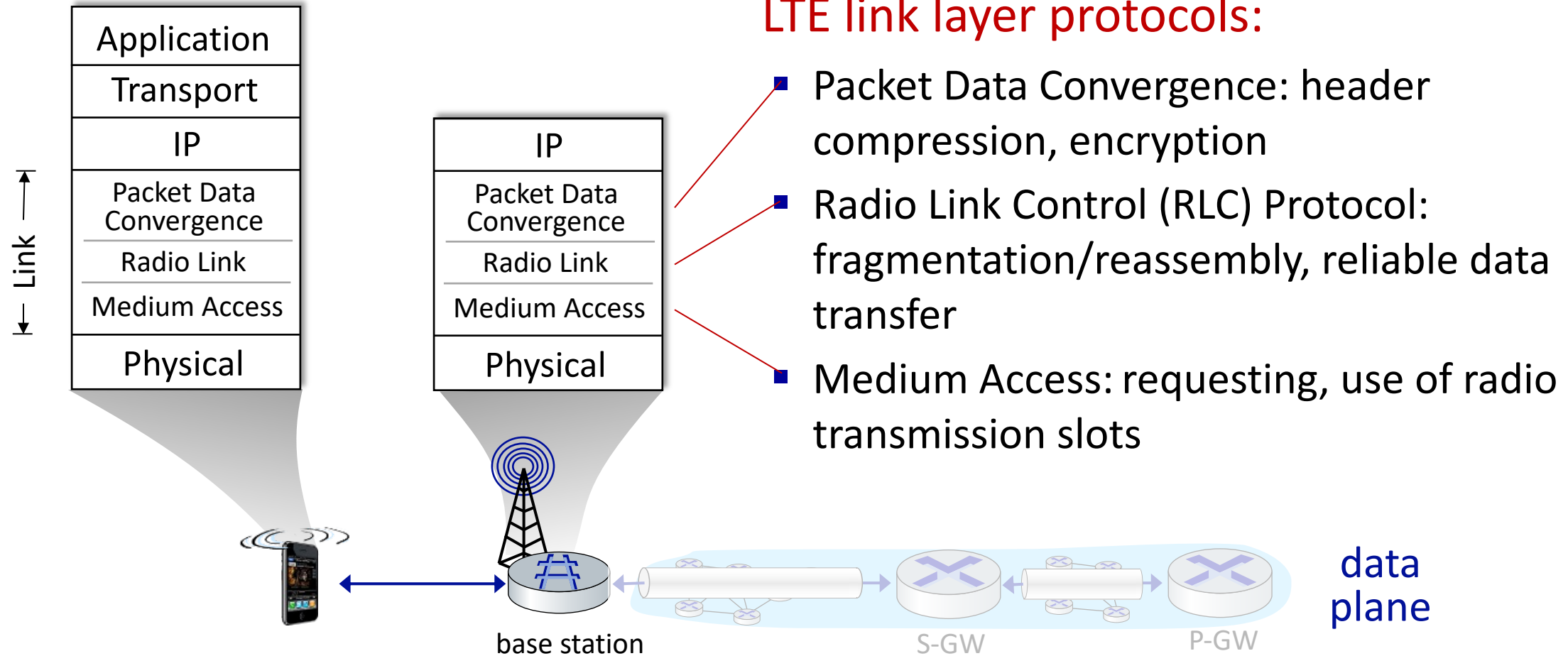

LTE data plane protocol stack: first hop

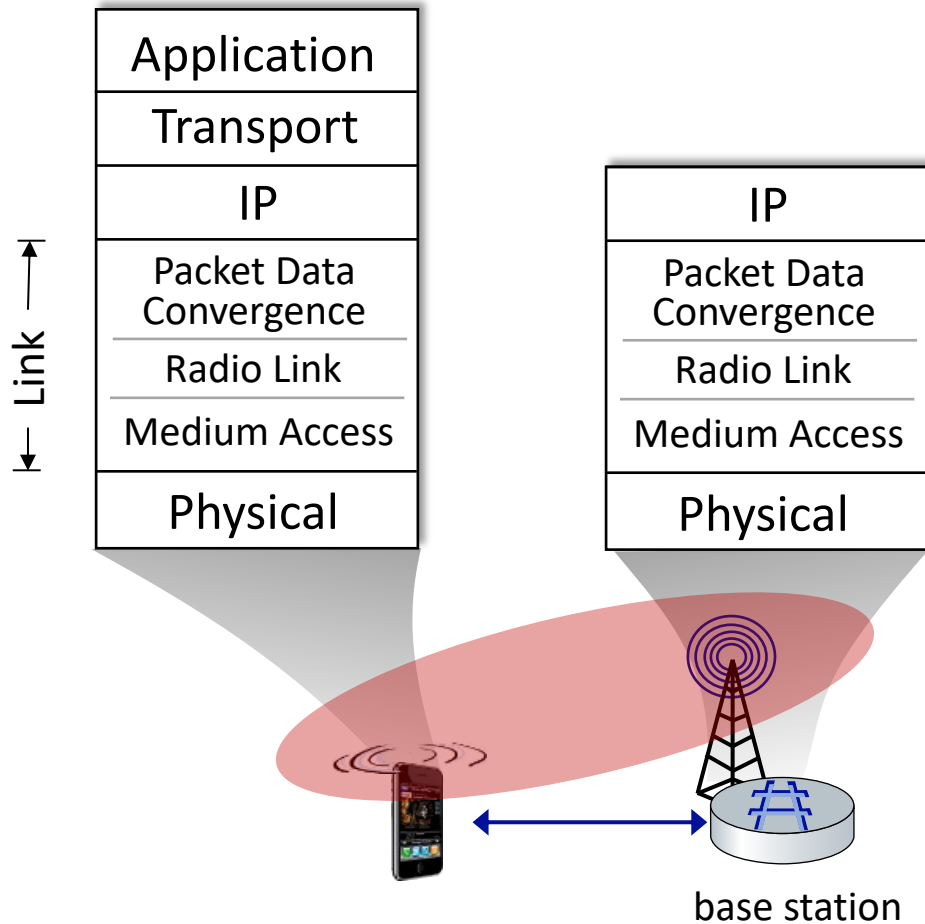

LTE radio access network:

- **downstream channel:** FDM, TDM within frequency channel (OFDM - orthogonal frequency division multiplexing)
 - “orthogonal”: minimal interference between channels
 - **upstream:** FDM, TDM similar to OFDM
- each active mobile device allocated two or more 0.5 ms time slots over 12 frequencies
 - scheduling algorithm not standardized – up to operator
 - 100’s Mbps per device possible

LTE data plane protocol stack: packet core

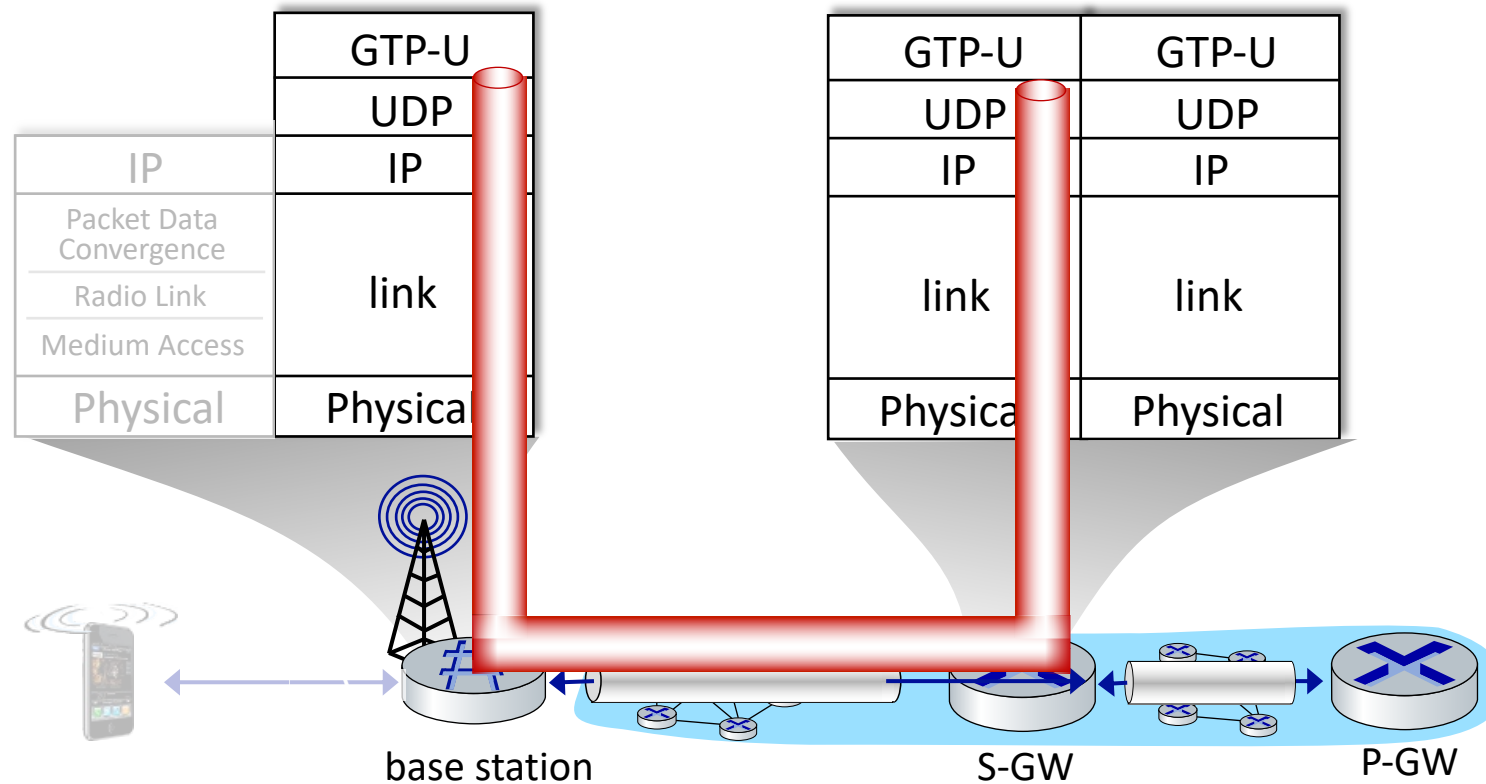

tunneling:

- mobile datagram encapsulated using GPRS Tunneling Protocol (GTP), sent inside UDP datagram to S-GW
- S-GW re-tunnels datagrams to P-GW
- supporting mobility: only tunneling endpoints change when mobile user moves

LTE data plane: associating with a BS

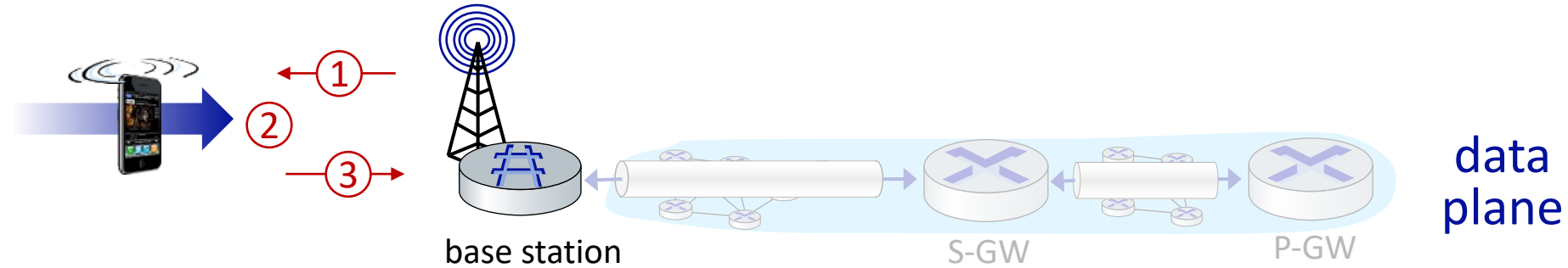

- ① BS broadcasts primary synch signal every 5 ms on all frequencies
 - BSs from multiple carriers may be broadcasting synch signals
- ② mobile finds a primary synch signal, then locates 2nd synch signal on this freq.
 - mobile then finds info broadcast by BS: channel bandwidth, configurations; BS's cellular carrier info
 - mobile may get info from multiple base stations, multiple cellular networks
- ③ mobile selects which BS to associate with (*e.g.*, preference for home carrier)
- ④ more steps still needed to authenticate, establish state, set up data plane

LTE mobiles: sleep modes

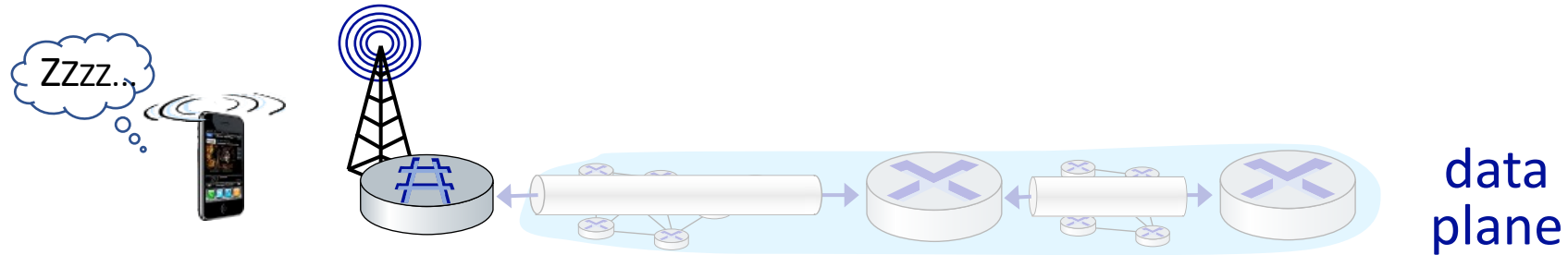

as in WiFi, Bluetooth: LTE mobile may put radio to “sleep” to conserve battery:

- **light sleep:** after 100’s msec of inactivity
 - wake up periodically (100’s msec) to check for downstream transmissions
- **deep sleep:** after 5-10 secs of inactivity
 - mobile may change cells while deep sleeping – need to re-establish association

Global cellular network: a network of IP networks

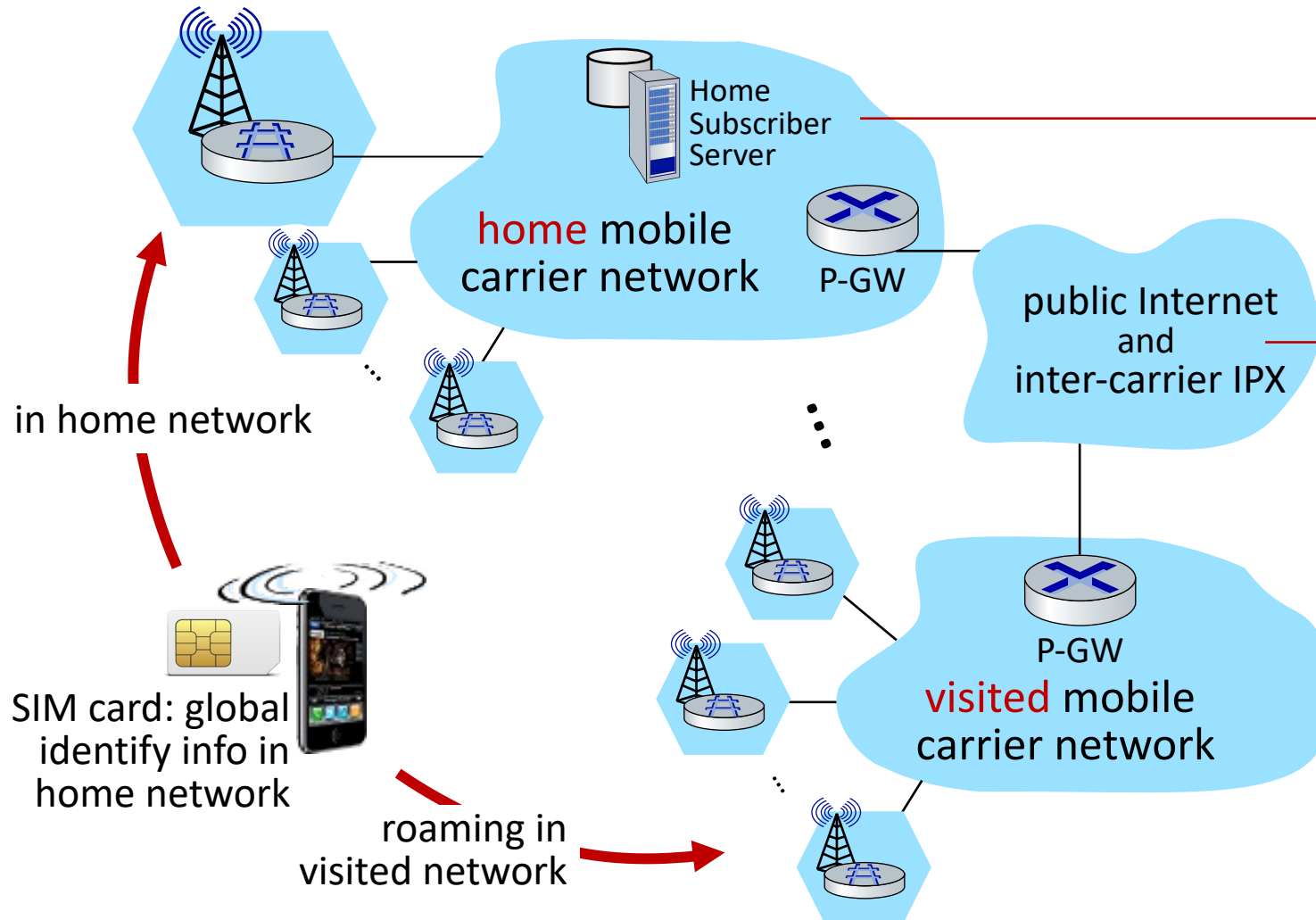

home network HSS:

- identify & services info, while in home network and roaming

all IP:

- carriers interconnect with each other, and public internet at exchange points
- legacy 2G, 3G: not all IP, handled otherwise

On to 5G!

- **goal:** 10x increase in peak bitrate, 10x decrease in latency, 100x increase in traffic capacity over 4G
- **5G NR (new radio):**
 - two frequency bands: FR1 (450 MHz–6 GHz) and FR2 (24 GHz–52 GHz): millimeter wave frequencies
 - not backwards-compatible with 4G
 - MIMO: multiple directional antennae
- **millimeter wave frequencies:** much higher data rates, but over shorter distances
 - pico-cells: cells diameters: 10-100 m
 - massive, dense deployment of new base stations required

Chapter 7 outline

- Introduction

Wireless

- Wireless links and network characteristics
- WiFi: 802.11 wireless LANs
- Cellular networks: 4G and 5G



Mobility

- **Mobility management: principles**
- Mobility management: practice
 - 4G/5G networks
 - Mobile IP
- Mobility: impact on higher-layer protocols

What is mobility?

- spectrum of mobility, from the **network** perspective:

no mobility

high mobility



device moves between networks, but powers down while moving

device moves within same AP in one provider network

device moves among APs in one provider network

device moves among multiple provider networks, while maintaining ongoing connections

We're interested in these!

Mobility challenge:

If a device moves from one network another:

- How will the “network” know to forward packets to the *new* network?

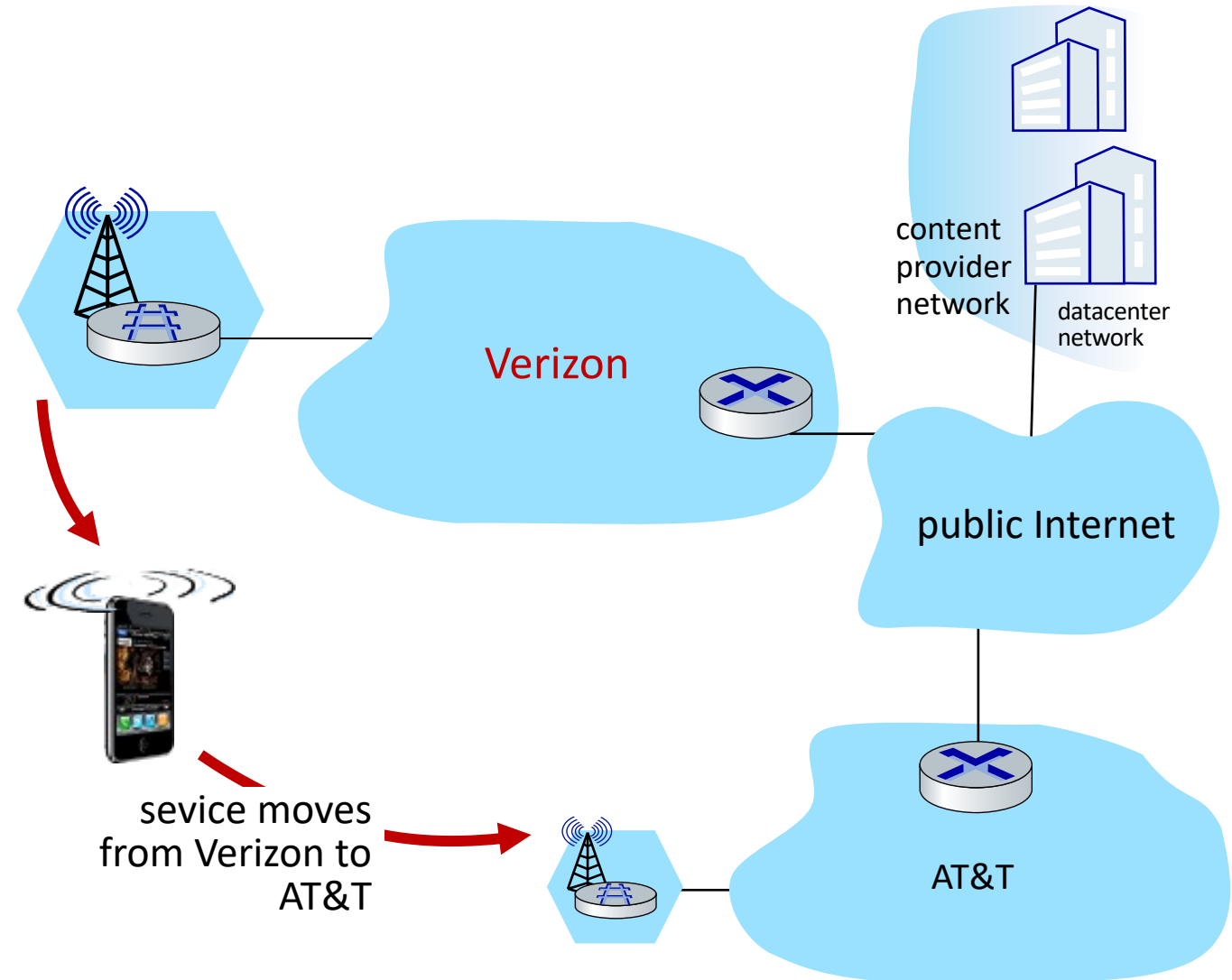

Mobility approaches

- **let network (routers) handle it:**
 - routers advertise well-known name, address (e.g., permanent 32-bit IP address), or number (e.g., cell #) of visiting mobile node via usual routing table exchange
 - Internet routing could do this already *with no* changes! Routing tables indicate where each mobile located via longest prefix match!

Mobility approaches

- let network (routers) handle it:
 - routers advertise well-known address (e.g., permanent 32-bit IP address), or number of visiting mobile node via usual routing table exchange
 - Internet routing could do *it* *with no changes!* Routing tables indicate where each mobile located via longest prefix match!
- **let end-systems handle it: functionality at the “edge”**
 - *indirect routing*: communication from correspondent to mobile goes through home network, then forwarded to remote mobile
 - *direct routing*: correspondent gets foreign address of mobile, send directly to mobile

not
scalable
to billions of
mobiles

Contacting a mobile friend:

Consider friend frequently changing locations, how do you find him/her?

- search all phone books?
- expect her to let you know where he/she is?
- call his/her parents?
- Facebook!

The importance of having a “home”:

- a definitive source of information about you
- a place where people can find out where you are



Home network, visited network: 4G/5G

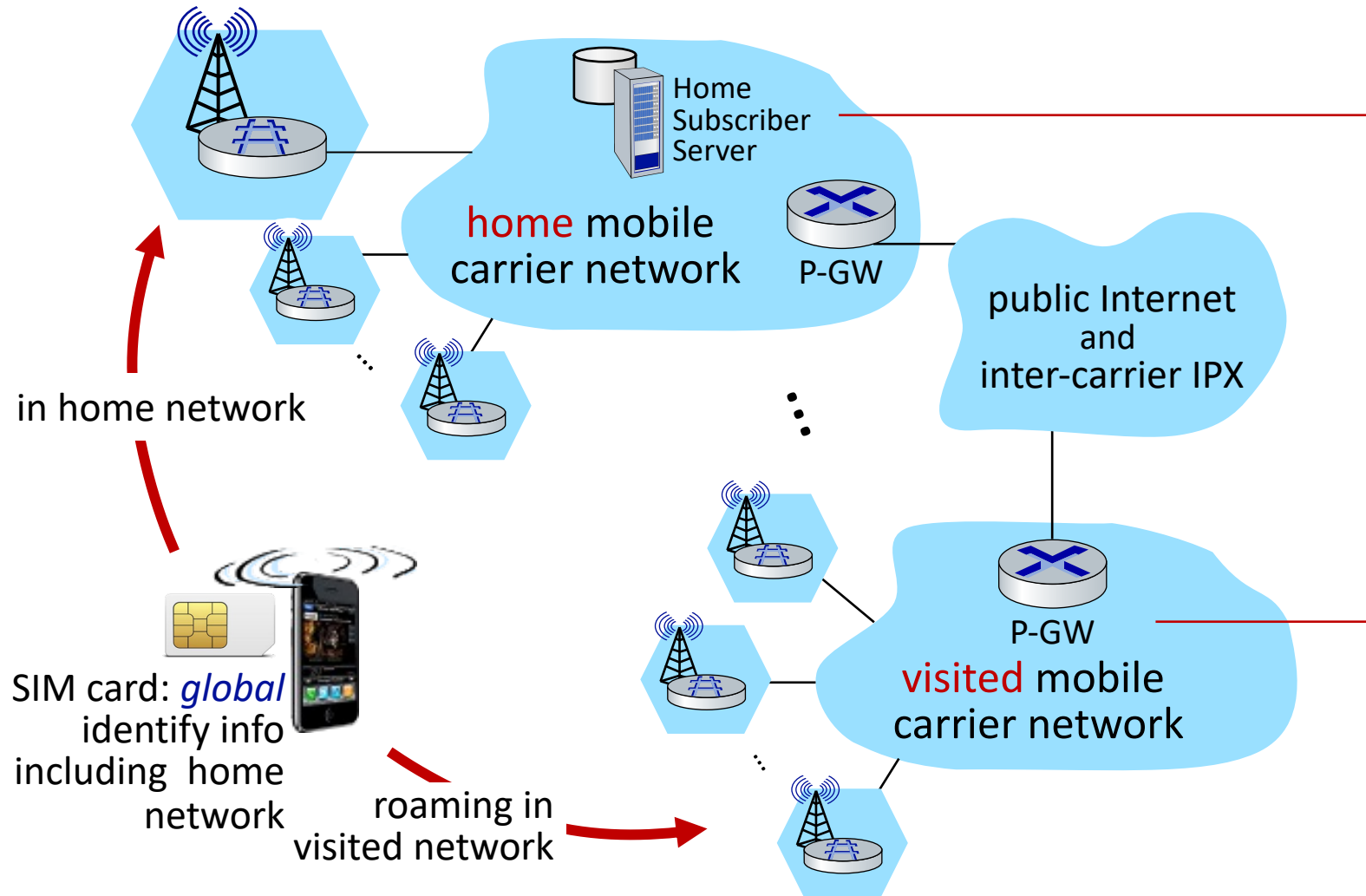

home network:

- (paid) service plan with cellular provider, e.g., Verizon, Orange
- home network HSS stores identify & services info

visited network:

- any network other than your home network
- service agreement with other networks: to provide access to visiting mobile

Home network, visited network: ISP/WiFi

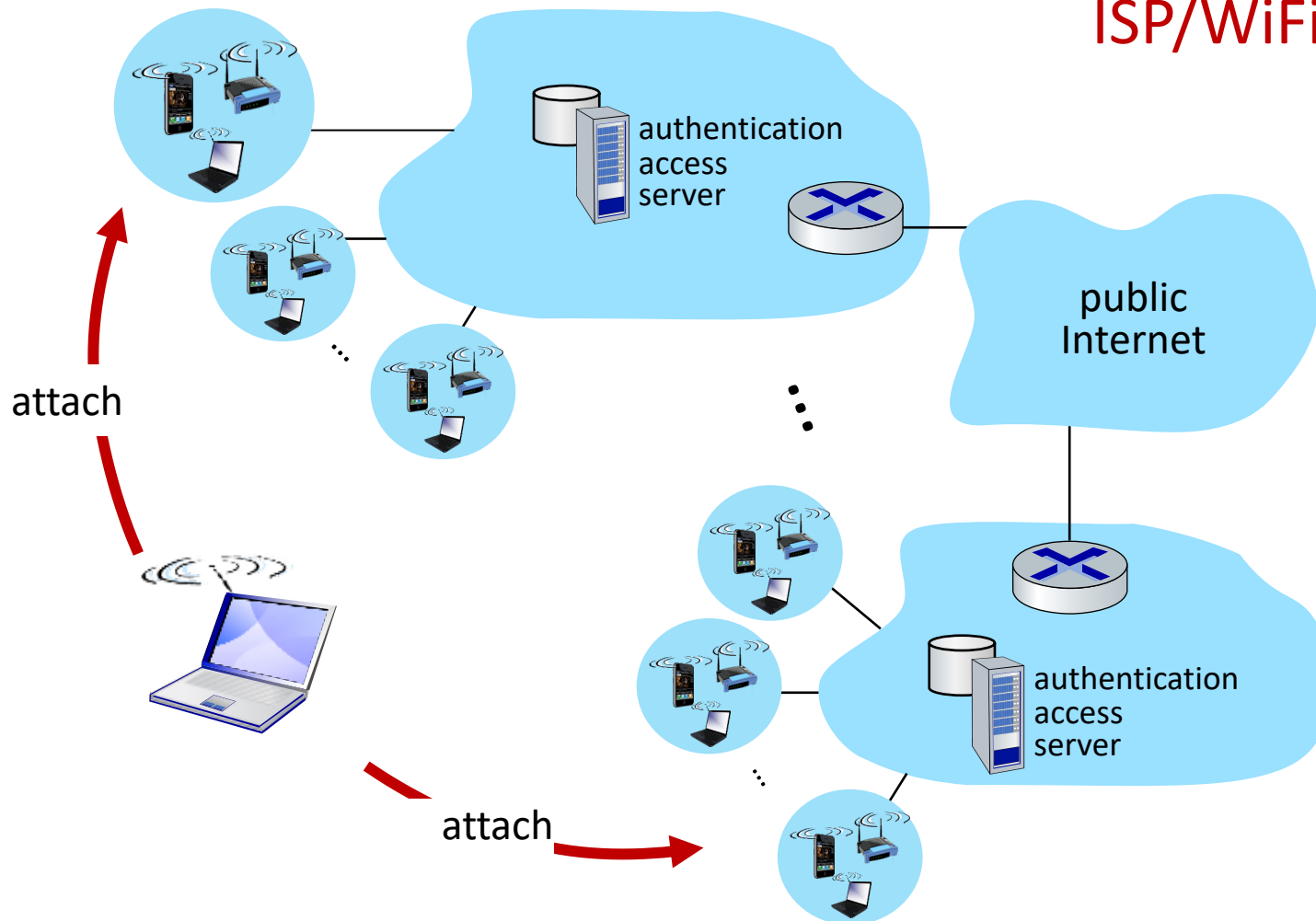

ISP/WiFi: no notion of global “home”

- credentials from ISP (e.g., username, password) stored on device or with user
- ISPs may have national, international presence
- different networks: different credentials
 - some exceptions (e.g., eduroam)
 - architectures exist (mobile IP) for 4G-like mobility, but not used

Home network, visited network: generic

Home Network

e.g.,: 128.119/16



Permanent IP:
128.119.40.186
IMSI
78:4f:43:98:d9:27

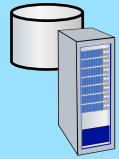

Home
Subscriber
Server



Mobility
manager



Home
network
gateway

Visited Network

e.g.,: 79.129/16



NAT IP:
10.0.0.99
IMSI
78:4f:43:98:d9:27



Mobility
manager

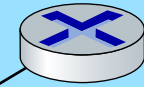

Visited
network
gateway

public or private
Internet



Correspondent

Registration: home needs to know where you are!

Home Network

e.g.,: 128.119/16

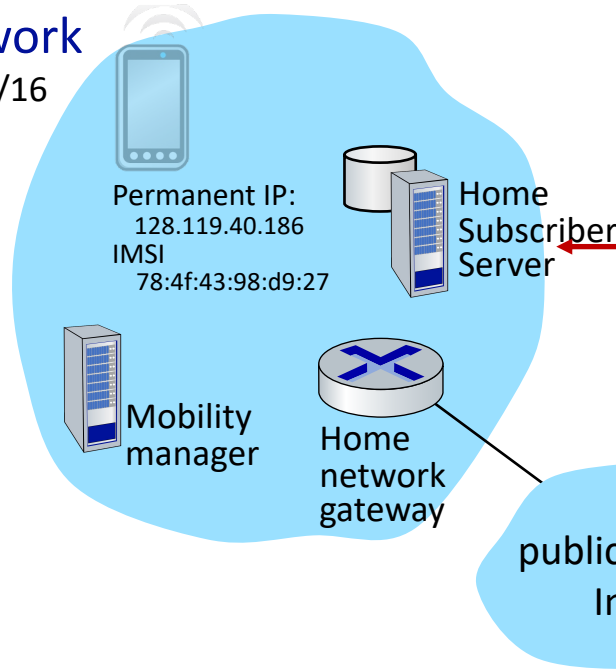

Visited Network

e.g.,: 79.129/16

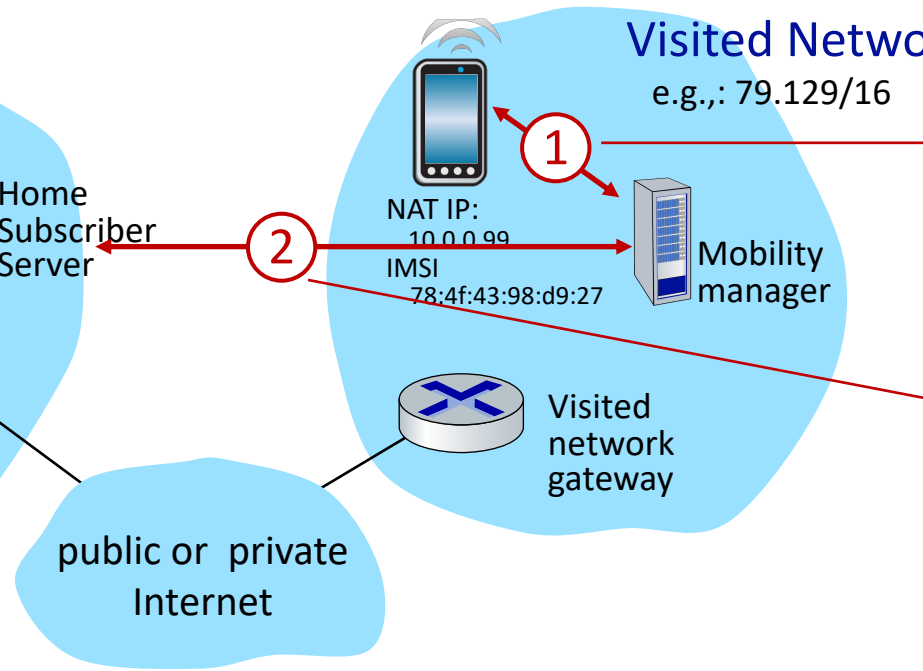

mobile *associates* with visited mobility manager

visited mobility manager *registers* mobile's location with home HSS

end result:

- visited mobility manager knows about mobile
- home HSS knows location of mobile

Mobility with indirect routing

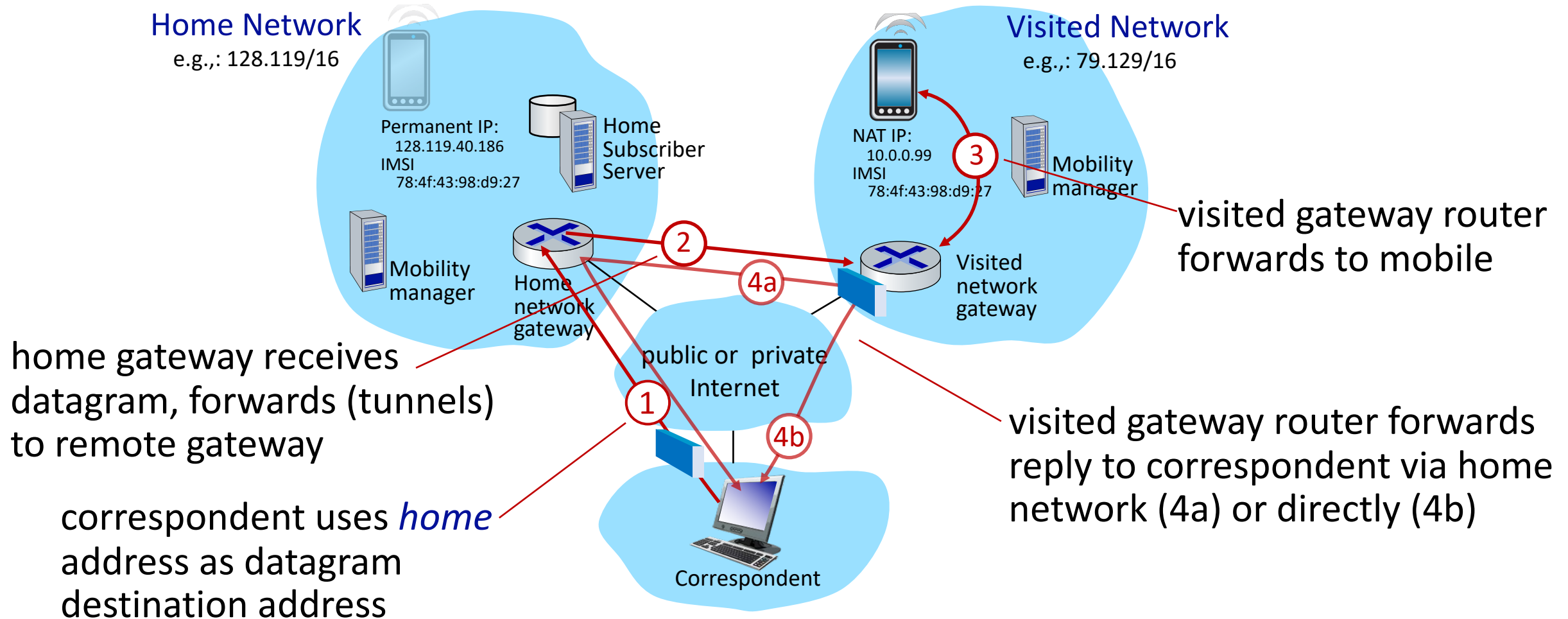

home gateway receives datagram, forwards (tunnels) to remote gateway

correspondent uses *home* address as datagram destination address

visited gateway router forwards to mobile

visited gateway router forwards reply to correspondent via home network (4a) or directly (4b)

Mobility with indirect routing: comments

- triangle routing:
 - inefficient when correspondent and mobile are in same network
- mobile moves among visited networks: transparent to correspondent!
 - registers in new visited network
 - new visited network registers with home HSS
 - datagrams continue to be forwarded from home network to mobile in new network
 - *on-going (e.g., TCP) connections between correspondent and mobile can be maintained!*

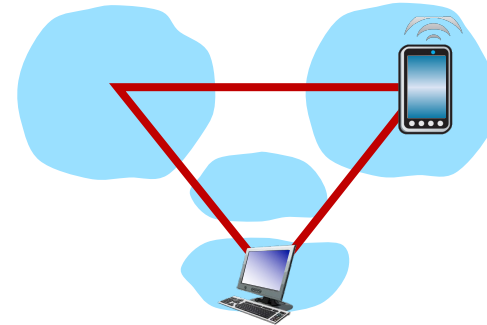

Mobility with direct routing

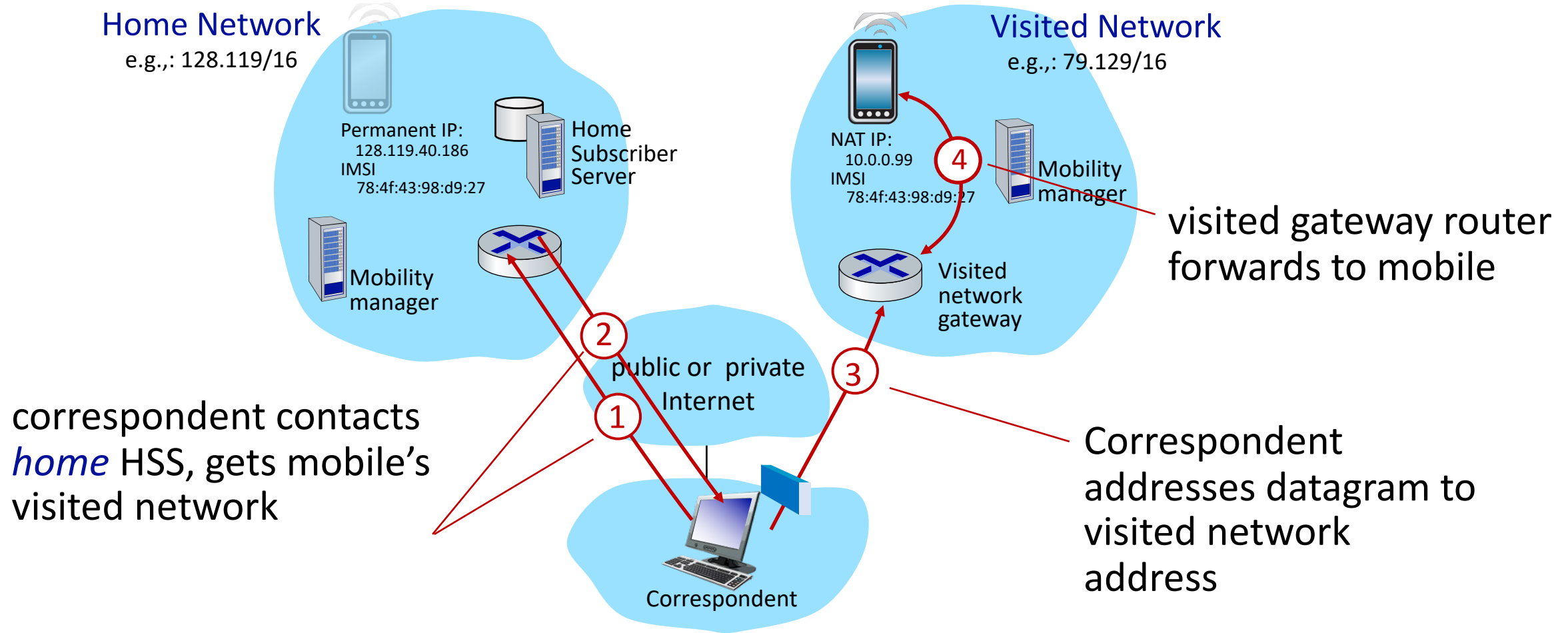

Mobility with direct routing: comments

- overcomes triangle routing inefficiencies
- *non-transparent to correspondent*: correspondent must get care-of-address from home agent
- what if mobile changes visited network?
 - can be handled, but with additional complexity

Chapter 7 outline

- Introduction

Wireless

- Wireless links and network characteristics
- WiFi: 802.11 wireless LANs
- Cellular networks: 4G and 5G



Mobility

- Mobility management: principles
- Mobility management: practice
 - 4G/5G networks
 - Mobile IP
- Mobility: impact on higher-layer protocols

Mobility in 4G networks: major mobility tasks

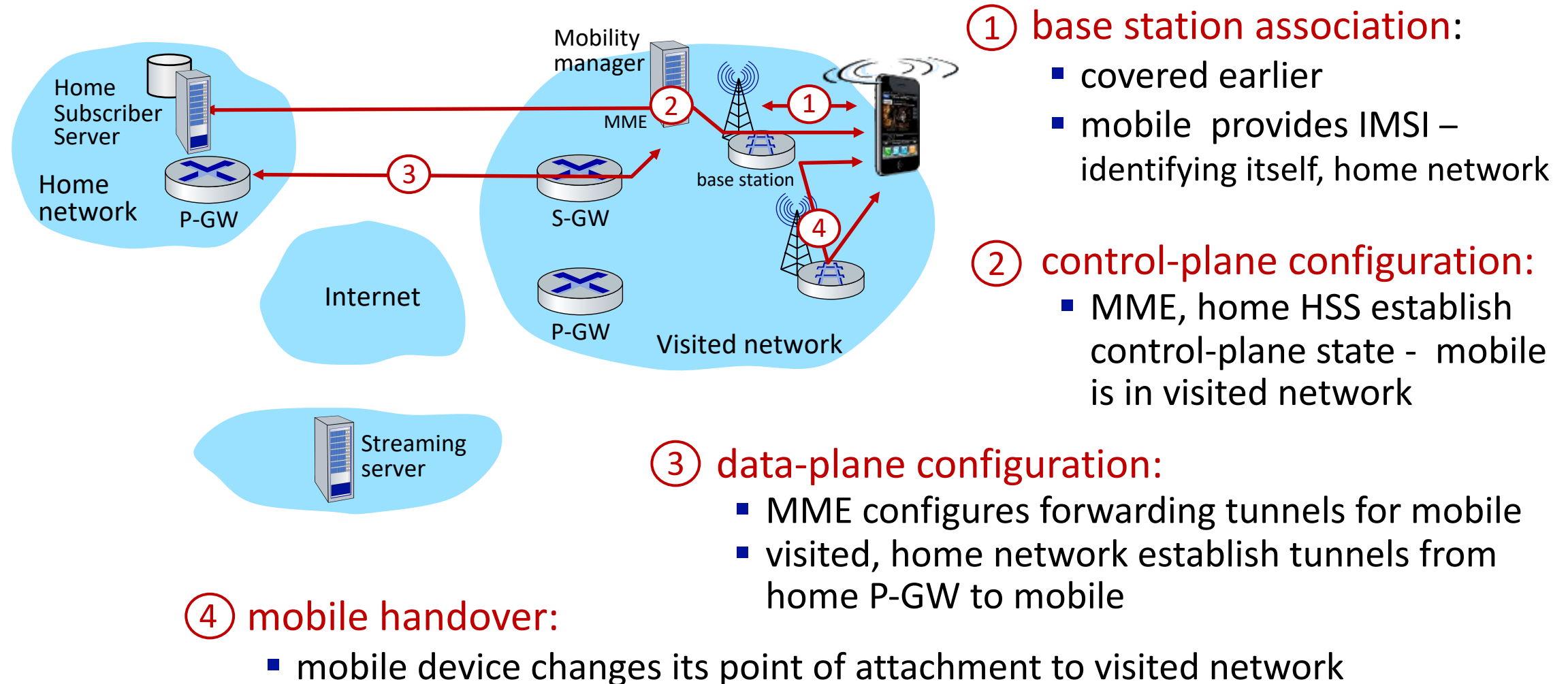

Configuring LTE control-plane elements

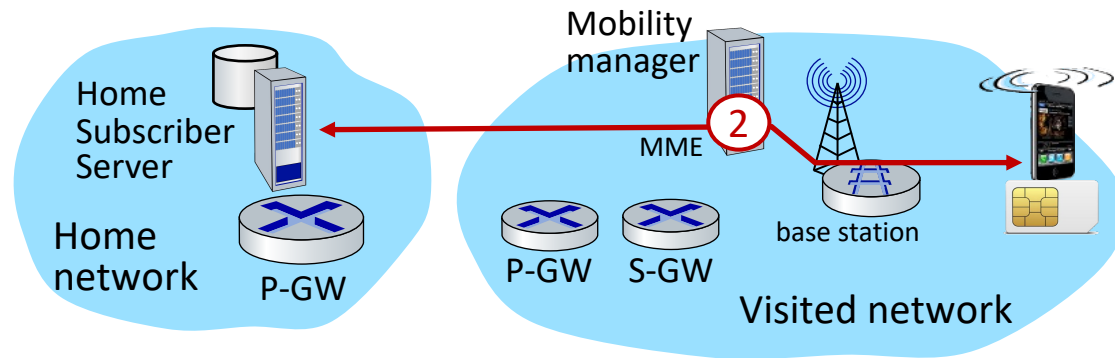

- Mobile communicates with local MME via BS control-plane channel
- MME uses mobile's IMSI info to contact mobile's home HSS
 - retrieve authentication, encryption, network service information
 - home HSS knows mobile now resident in visited network
- BS, mobile select parameters for BS-mobile data-plane radio channel

Configuring data-plane tunnels for mobile

- **S-GW to BS tunnel:** when mobile changes base stations, simply change endpoint IP address of tunnel
- **S-GW to home P-GW tunnel:** implementation of indirect routing
- **tunneling via GTP** (GPRS tunneling protocol): mobile's datagram to streaming server encapsulated using GTP inside UDP, inside datagram

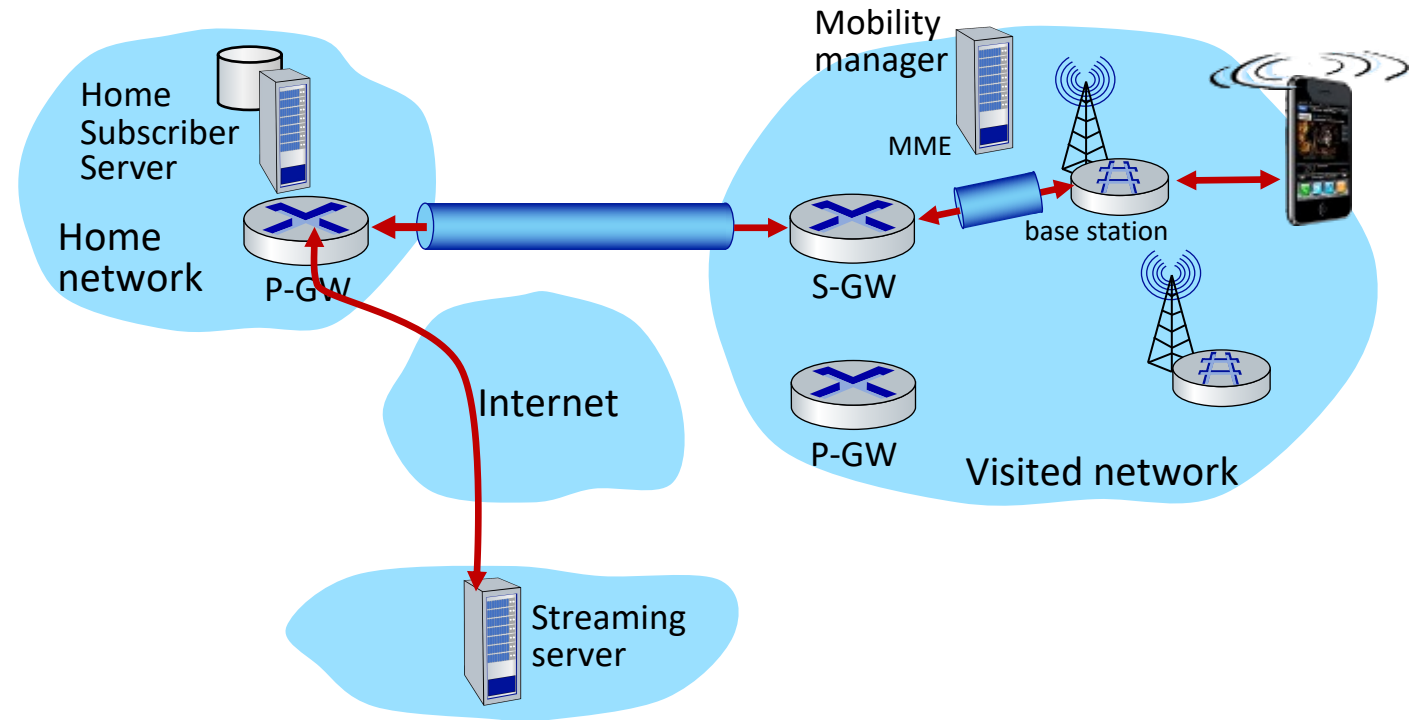

Handover between BSs in same cellular network

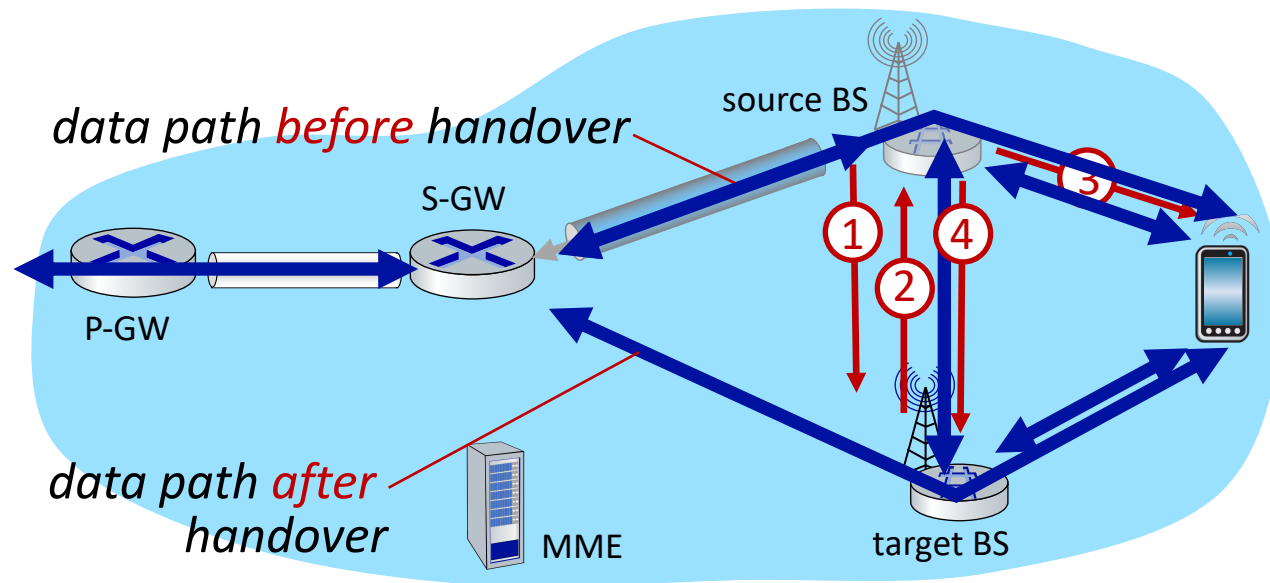

- ① current (source) BS selects target BS, sends *Handover Request message* to target BS
- ② target BS pre-allocates radio time slots, responds with HR ACK with info for mobile
- ③ source BS informs mobile of new BS
 - mobile can now send via new BS - handover *looks* complete to mobile
- ④ source BS stops sending datagrams to mobile, instead forwards to new BS (who forwards to mobile over radio channel)

Handover between BSs in same cellular network

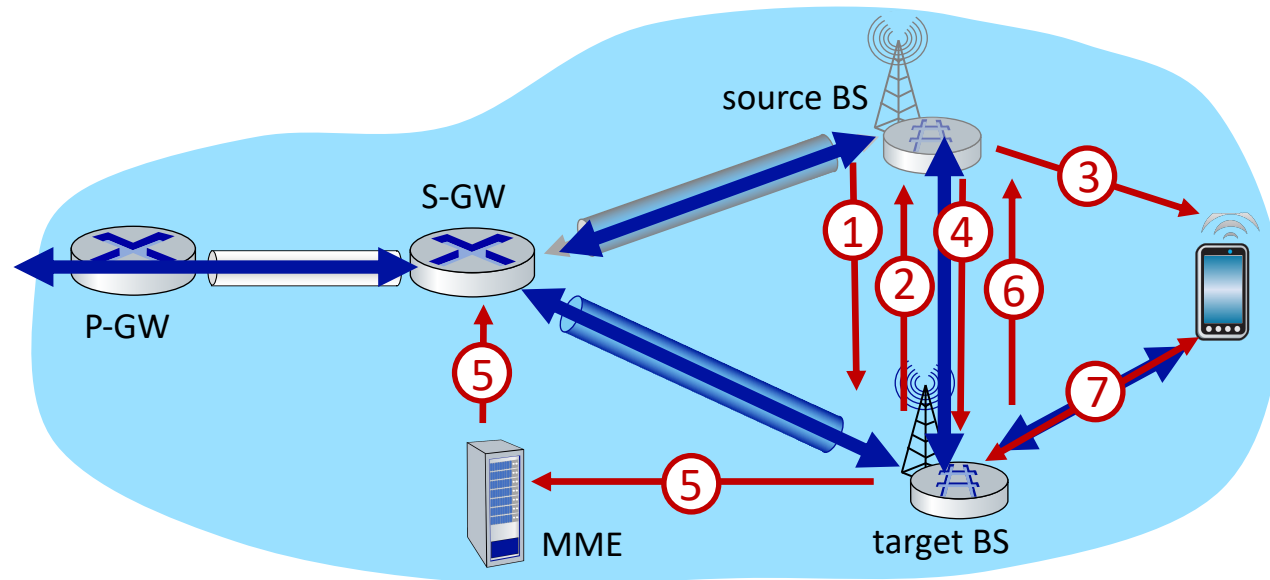

- ⑤ target BS informs MME that it is new BS for mobile
- MME instructs S-GW to change tunnel endpoint to be (new) target BS

- ⑥ target BS ACKs back to source BS: handover complete, source BS can release resources

- ⑦ mobile's datagrams now flow through new tunnel from target BS to S-GW

Handover is effective to support mobility in cellular networks,

But, is it that simple?

Check recent research done my group,

<https://www.cs.purdue.edu/homes/chunyi/>

HotMobile'24, CoNext'23, MobiCom'23, INFOCOM'23, ICNP'21,
MobiCom'20, SIGMETICS'16 ...

Mobile IP

- mobile IP architecture standardized ~20 years ago [RFC 5944]
 - long before ubiquitous smartphones, 4G support for Internet protocols
 - did not see wide deployment/use
 - perhaps WiFi for Internet, and 2G/3G phones for voice were “good enough” at the time
- mobile IP architecture:
 - indirect routing to node (via home network) using tunnels
 - mobile IP home agent: combined roles of 4G HSS and home P-GW
 - mobile IP foreign agent: combined roles of 4G MME and S-GW
 - protocols for agent discovery in visited network, registration of visited location in home network via ICMP extensions

Wireless, mobility: impact on higher layer protocols

- logically, impact *should* be minimal ...
 - best effort service model remains unchanged
 - TCP and UDP can (and do) run over wireless, mobile
- ... but performance-wise:
 - packet loss/delay due to bit-errors (discarded packets, delays for link-layer retransmissions), and handover loss
 - TCP interprets loss as congestion, will decrease congestion window unnecessarily
 - delay impairments for real-time traffic
 - bandwidth a scarce resource for wireless links

Chapter 7 summary

Wireless

- Wireless Links and network characteristics
- WiFi: 802.11 wireless LANs
- Cellular networks: 4G and 5G

Mobility

- Mobility management: principles
- Mobility management: practice
 - 4G/5G networks
 - Mobile IP
- Mobility: impact on higher-layer protocols

